

# PM75B6LA060

FLAT-BASE TYPE  
INSULATED PACKAGE

## PM75B6LA060



### FEATURE

- a) Adopting new 5th generation IGBT (CSTBT™) chip, which performance is improved by 1μm fine rule process.  
For example, typical  $V_{ce(sat)}=1.55V @T_j=125^{\circ}C$
- b) Over-temperature protection by detecting  $T_j$  of the CSTBT™ chips and error output is possible from all each conservation upper and lower arm of IPM.
- c) New small package  
Reduce the package size by 10%, thickness by 22% from S-DASH series.
  - 2φ 75A, 600V Current-sense IGBT type inverter
  - 75A, 600V Current-sense Chopper IGBT
  - Monolithic gate drive & protection logic
  - Detection, protection & status indication circuits for, short-circuit, over-temperature & under-voltage (P-Fo available from upper arm devices)
  - UL Recognized Yellow Card No.E80276(N)  
File No.E80271

## APPLICATION

Photo voltaic power conditioner

## PACKAGE OUTLINES

Dimensions in mm

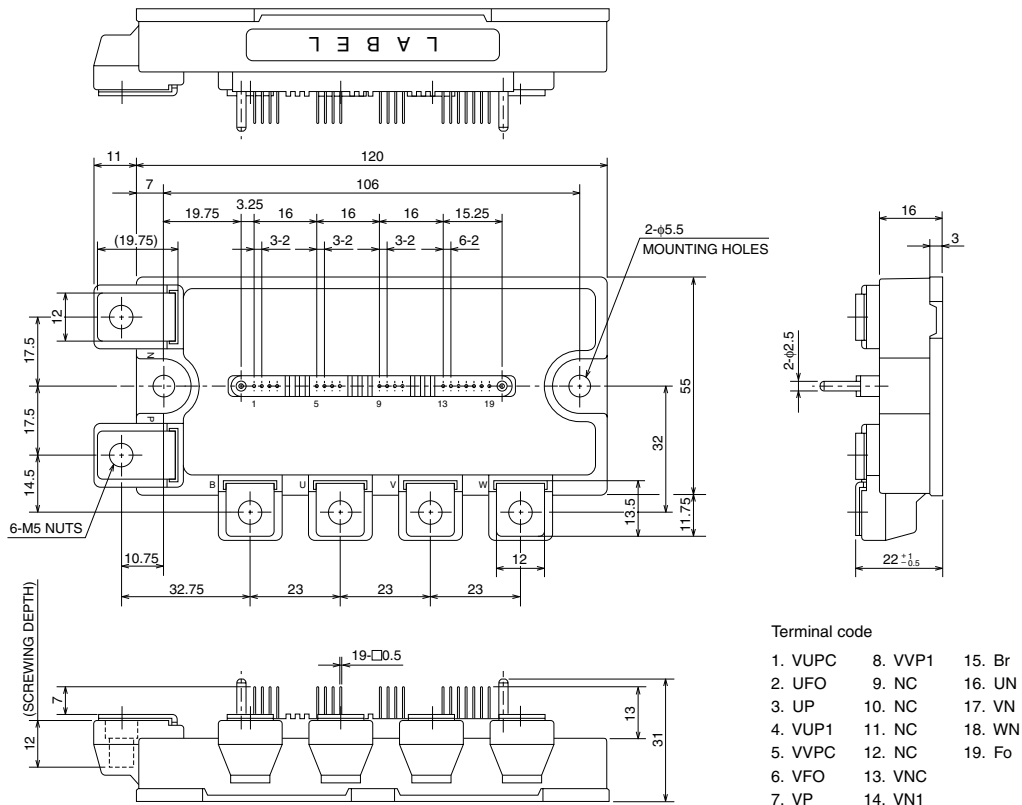

# PM75B6LA060

FLAT-BASE TYPE  
INSULATED PACKAGE

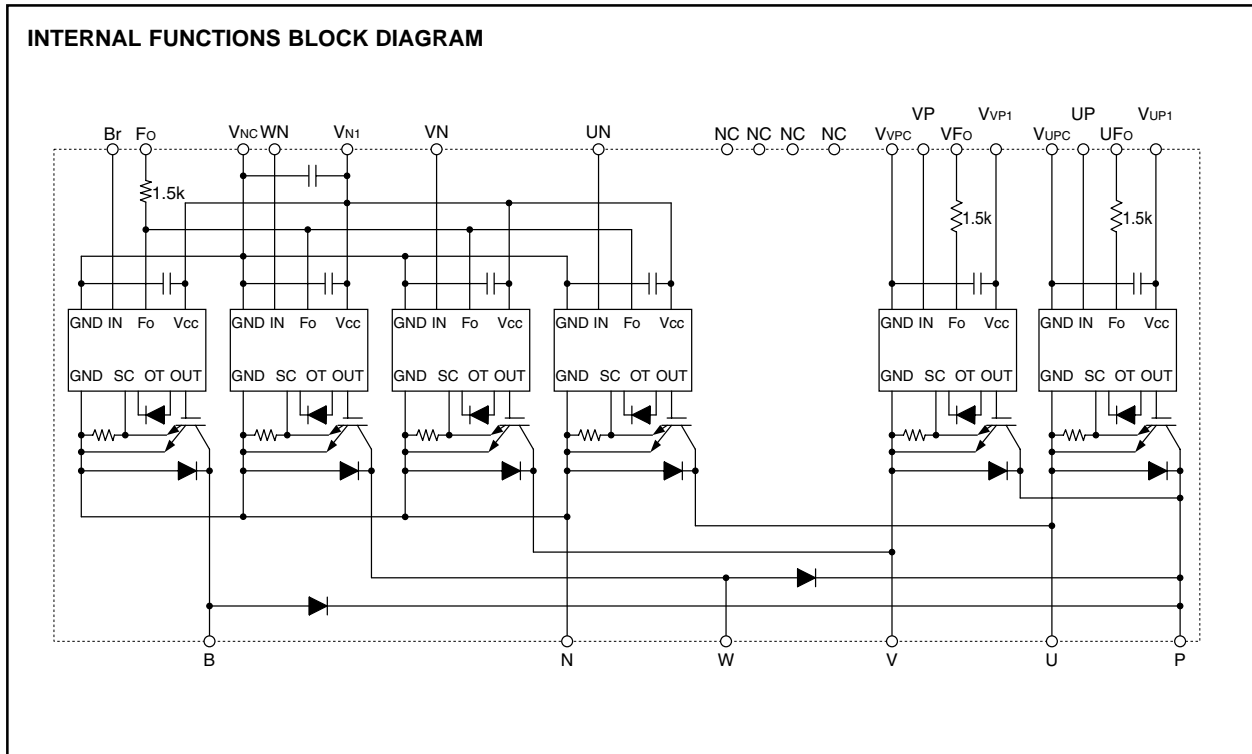

**MAXIMUM RATINGS** (Tj = 25°C, unless otherwise noted)

**INVERTER PART**

| Symbol           | Parameter                 | Condition                                    | Ratings    | Unit |
|------------------|---------------------------|--|------------|------|
| V <sub>CES</sub> | Collector-Emitter Voltage | V <sub>D</sub> = 15V, V <sub>CIN</sub> = 15V | 600        | V    |
| ±I <sub>C</sub>  | Collector Current         | T <sub>C</sub> = 25°C                        | 75         | A    |
| ±I <sub>CP</sub> | Collector Current (Peak)  | T <sub>C</sub> = 25°C                        | 150        | A    |
| P <sub>C</sub>   | Collector Dissipation     | T <sub>C</sub> = 25°C                        | 390        | W    |
| T <sub>j</sub>   | Junction Temperature      |  | -20 ~ +150 | °C   |

**CONVERTER PART**

| Symbol             | Parameter                     | Condition                                    | Ratings    | Unit |
|--------------------|-------------------------------|--|------------|------|
| V <sub>CES</sub>   | Collector-Emitter Voltage     | V <sub>D</sub> = 15V, V <sub>CIN</sub> = 15V | 600        | V    |
| I <sub>C</sub>     | Collector Current             | T <sub>C</sub> = 25°C                        | 75         | A    |
| I <sub>CP</sub>    | Collector Current (Peak)      | T <sub>C</sub> = 25°C                        | 150        | A    |
| P <sub>C</sub>     | Collector Dissipation         | T <sub>C</sub> = 25°C (Note-1)               | 390        | W    |
| I <sub>F</sub>     | FWDi Forward Current          | T <sub>C</sub> = 25°C                        | 75         | A    |
| V <sub>R(DC)</sub> | FWDi Rated DC Reverse Voltage | T <sub>C</sub> = 25°C                        | 600        | V    |
| T <sub>j</sub>     | Junction Temperature          |  | -20 ~ +150 | °C   |

**CONTROL PART**

| Symbol           | Parameter                   | Condition   | Ratings | Unit |
|------------------|-----------------------------|---|---------|------|
| V <sub>D</sub>   | Supply Voltage              | Applied between : V <sub>UP1</sub> -V <sub>UPC</sub><br>V <sub>VPC</sub> -V <sub>VPC</sub> , V <sub>N1</sub> -V <sub>N1</sub>   | 20      | V    |
| V <sub>CIN</sub> | Input Voltage               | Applied between : U <sub>P</sub> -V <sub>UPC</sub> , V <sub>P</sub> -V <sub>VPC</sub><br>U <sub>N</sub> • V <sub>N</sub> • W <sub>N</sub> • B <sub>R</sub> -V <sub>N1</sub> | 20      | V    |
| V <sub>F0</sub>  | Fault Output Supply Voltage | Applied between : U <sub>F0</sub> -V <sub>UPC</sub> , V <sub>F0</sub> -V <sub>VPC</sub> , F <sub>0</sub> -V <sub>N1</sub>   | 20      | V    |
| I <sub>F0</sub>  | Fault Output Current        | Sink current at U <sub>F0</sub> , V <sub>F0</sub> , F <sub>0</sub> terminals  | 20      | mA   |

# PM75B6LA060

FLAT-BASE TYPE  
INSULATED PACKAGE

## TOTAL SYSTEM

| Symbol           | Parameter                      | Condition  | Ratings    | Unit             |
|------------------|--------------------------------|--|------------|------------------|
| VCC(PROT)        | Supply Voltage Protected by SC | V <sub>D</sub> = 13.5 ~ 16.5V, Inverter Part,<br>T <sub>j</sub> = +125°C Start | 400        | V                |
| VCC(surge)       | Supply Voltage (Surge)         | Applied between : P-N, Surge value   | 500        | V                |
| T <sub>stg</sub> | Storage Temperature            |  | -40 ~ +125 | °C               |
| V <sub>iso</sub> | Isolation Voltage              | 60Hz, Sinusoidal, Charged part to Base, AC 1 min.                              | 2500       | V <sub>rms</sub> |

## THERMAL RESISTANCES

| Symbol                | Parameter                            | Condition  | Limits |      |       | Unit |
|-----------------------|--------------------------------------|--|--------|------|-------|------|
|                       |                                      |  | Min.   | Typ. | Max.  |      |
| R <sub>th(j-c)Q</sub> | Junction to case Thermal Resistances | Inverter IGBT part (per 1/4 module) (Note-1)                   | —      | —    | 0.32  | °C/W |
| R <sub>th(j-c)F</sub> |                                      | Inverter FWDi part (per 1/4 module) (Note-1)                   | —      | —    | 0.53  |      |
| R <sub>th(j-c)Q</sub> |                                      | Converter IGBT part (Note-1)                                   | —      | —    | 0.32  |      |
| R <sub>th(j-c)F</sub> |                                      | Converter FWDi upper part (Note-1)                             | —      | —    | 0.33  |      |
| R <sub>th(j-c)F</sub> |                                      | Converter FWDi lower part (Note-1)                             | —      | —    | 0.53  |      |
| R <sub>th(c-f)</sub>  | Contact Thermal Resistance           | Case to fin, (per 1 module)<br>Thermal grease applied (Note-1) | —      | —    | 0.038 |      |

(Note-1) T<sub>c</sub> (under the chip) measurement point is below.

(unit : mm)

| axis \ arm | UP   |      | VP   |      | WP   | BP   | UN   |      | VN   |      | WN   |      | BN    |      |
|------------|------|------|------|------|------|------|------|------|------|------|------|------|-------|------|
|            | IGBT | FWDi | IGBT | FWDi | FWDi | FWDi | IGBT | FWDi | IGBT | FWDi | IGBT | FWDi | IGBT  | FWDi |
| X          | 33.6 | 31.2 | 66.0 | 66.0 | 85.8 | 22.7 | 40.5 | 41.6 | 56.2 | 56.2 | 76.3 | 76.3 | 18.7  | 26.1 |
| Y          | -7.5 | 4.5  | -8.6 | 0.6  | -3.1 | 7.2  | 8.0  | 0.0  | 2.7  | -5.5 | 2.7  | -6.5 | -10.1 | -9.0 |

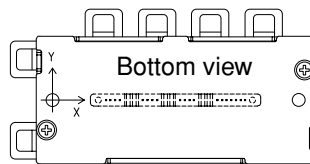

## ELECTRICAL CHARACTERISTICS (T<sub>j</sub> = 25°C, unless otherwise noted)

### INVERTER PART

| Symbol               | Parameter                            | Condition  | Limits                 |      |      | Unit |    |
|----------------------|--------------------------------------|--|------------------------|------|------|------|----|
|                      |                                      |  | Min.                   | Typ. | Max. |      |    |
| V <sub>CE(sat)</sub> | Collector-Emitter Saturation Voltage | V <sub>D</sub> = 15V, I <sub>C</sub> = 75A<br>V <sub>CIN</sub> = 0V (Fig. 1)   | T <sub>j</sub> = 25°C  | —    | 1.7  | —    | V  |
|                      |                                      |  | T <sub>j</sub> = 125°C | —    | 1.55 | —    |    |
| V <sub>EC</sub>      | FWDi Forward Voltage                 | -I <sub>C</sub> = 75A, V <sub>D</sub> = 15V, V <sub>CIN</sub> = 15V (Fig. 2)   | —                      | 2.2  | 3.3  | V    |    |
| t <sub>on</sub>      | Switching Time                       | V <sub>D</sub> = 15V, V <sub>CIN</sub> = 0V↔15V<br>V <sub>CC</sub> = 300V, I <sub>C</sub> = 75A<br>T <sub>j</sub> = 125°C<br>Inductive Load (Fig. 3,4) | —                      | 0.3  | 0.7  | 1.4  | μs |
| t <sub>tr</sub>      |                                      |  | —                      | 0.1  | 0.2  |      |    |
| t <sub>c(on)</sub>   |                                      |  | —                      | 0.2  | 0.4  |      |    |
| t <sub>off</sub>     |                                      |  | —                      | 0.9  | 1.8  |      |    |
| t <sub>c(off)</sub>  |                                      |  | —                      | 0.2  | 0.4  |      |    |
| I <sub>CES</sub>     | Collector-Emitter Cutoff Current     | V <sub>CE</sub> = V <sub>CES</sub> , V <sub>CIN</sub> = 15V (Fig. 5)   | T <sub>j</sub> = 25°C  | —    | —    | 1    | mA |
|                      |                                      |  | T <sub>j</sub> = 125°C | —    | —    | 10   |    |

## PM75B6LA060

FLAT-BASE TYPE  
INSULATED PACKAGE

## CONVERTER PART

| Symbol               | Parameter                            | Condition  | Limits                 |      |      | Unit |    |
|----------------------|--------------------------------------|--|------------------------|------|------|------|----|
|                      |                                      |  | Min.                   | Typ. | Max. |      |    |
| V <sub>CE(sat)</sub> | Collector-Emitter Saturation Voltage | V <sub>D</sub> = 15V, I <sub>C</sub> = 75A<br>V <sub>CIN</sub> = 0V, Pulsed (Fig. 1) | T <sub>J</sub> = 25°C  | —    | 1.7  | —    | V  |
|                      |                                      |  | T <sub>J</sub> = 125°C | —    | 1.55 | —    |    |
| V <sub>EC</sub>      | FWDi Forward Voltage                 | -I <sub>C</sub> = 75A, V <sub>CIN</sub> = 15V, V <sub>D</sub> = 15V (Fig. 2)         | —                      | 2.2  | 3.3  | V    |    |
| V <sub>FM</sub>      | Forward Voltage                      | I <sub>F</sub> = 75A   | —                      | 1.9  | 3.0  | V    |    |
| I <sub>CES</sub>     | Collector-Emitter Cutoff Current     | V <sub>CE</sub> = V <sub>CES</sub> , V <sub>D</sub> = 15V (Fig. 5)                   | T <sub>J</sub> = 25°C  | —    | —    | 1    | mA |
|                      |                                      |  | T <sub>J</sub> = 125°C | —    | —    | 10   |    |

## CONTROL PART

| Symbol               | Parameter                               | Condition   | Limits              |      |      | Unit |    |
|----------------------|---|---|---------------------|------|------|------|----|
|                      |   |   | Min.                | Typ. | Max. |      |    |
| I <sub>D</sub>       | Circuit Current                         | V <sub>D</sub> = 15V, V <sub>CIN</sub> = 15V                  | V <sub>N1-VNC</sub> | —    | 24   | 34   | mA |
|                      |   |   | V <sub>P1-VPC</sub> | —    | 6    | 12   |    |
| V <sub>th(ON)</sub>  | Input ON Threshold Voltage              | Applied between : UP-VUPC, VP-VVPC<br>UN • VN • WN • Br-VNC   | —                   | 1.2  | 1.5  | 1.8  | V  |
| V <sub>th(OFF)</sub> | Input OFF Threshold Voltage             |   | —                   | 1.7  | 2.0  | 2.3  |    |
| SC                   | Short Circuit Trip Level                | -20 ≤ T <sub>J</sub> ≤ 125°C, V <sub>D</sub> = 15V (Fig. 3,6) | Inverter part       | 150  | —    | —    | A  |
|                      |   |   | Converter part      | 150  | —    | —    |    |
| t <sub>off(SC)</sub> | Short Circuit Current Delay Time        | V <sub>D</sub> = 15V (Fig. 3,6)                               | —                   | 0.2  | —    | μs   |    |
| OT                   | Over Temperature Protection             | V <sub>D</sub> = 15V<br>Detect T <sub>J</sub> of IGBT chip    | Trip level          | 135  | 145  | —    | °C |
|                      |   |   | Reset level         | —    | 125  | —    |    |
| UV                   | Supply Circuit Under-Voltage Protection | -20 ≤ T <sub>J</sub> ≤ 125°C                                  | Trip level          | 11.5 | 12.0 | 12.5 | V  |
|                      |   |   | Reset level         | —    | 12.5 | —    |    |
| I <sub>FO(H)</sub>   | Fault Output Current                    | V <sub>D</sub> = 15V, V <sub>FO</sub> = 15V (Note-2)          | —                   | —    | 0.01 | mA   |    |
| I <sub>FO(L)</sub>   |   |   | —                   | 10   | 15   |      |    |
| t <sub>FO</sub>      | Minimum Fault Output Pulse Width        | V <sub>D</sub> = 15V (Note-2)                                 | 1.0                 | 1.8  | —    | ms   |    |

(Note-2) Fault output is given only when the internal SC, OT & UV protections schemes of either upper or lower arm device operate to protect it.

## MECHANICAL RATINGS AND CHARACTERISTICS

| Symbol | Parameter       | Condition                | Limits |      |      | Unit  |
|--------|-----------------|--------------------------|--------|------|------|-------|
|        |                 |                          | Min.   | Typ. | Max. |       |
| —      | Mounting torque | Main terminal screw : M5 | 2.5    | 3.0  | 3.5  | N • m |
| —      | Mounting torque | Mounting part screw : M5 | 2.5    | 3.0  | 3.5  | N • m |
| —      | Weight          | —                        | —      | 380  | —    | g     |

## RECOMMENDED CONDITIONS FOR USE

| Symbol                | Parameter                       | Condition   | Recommended value | Unit |
|-----------------------|---------------------------------|---|-------------------|------|
| V <sub>CC</sub>       | Supply Voltage                  | Applied across P-N terminals  | ≤ 400             | V    |
| V <sub>D</sub>        | Control Supply Voltage          | Applied between : V <sub>UP1-VUPC</sub> , V <sub>VP1-VVPC</sub><br>V <sub>N1-VNC</sub> (Note-3) | 15 ± 1.5          | V    |
| V <sub>CIN(ON)</sub>  | Input ON Voltage                | Applied between : UP-VUPC, VP-VVPC<br>UN • VN • WN • Br-VNC                                     | ≤ 0.8             | V    |
| V <sub>CIN(OFF)</sub> | Input OFF Voltage               |   | ≥ 9.0             |      |
| f <sub>PWM</sub>      | PWM Input Frequency             | Using Application Circuit of Fig. 8   | ≤ 20              | kHz  |
| t <sub>dead</sub>     | Arm Shoot-through Blocking Time | For IPM's each input signals (Fig. 7)   | ≥ 2.0             | μs   |

(Note-3) With ripple satisfying the following conditions : dv/dt swing ≤ ±5V/μs, Variation ≤ 2V peak to peak

# PM75B6LA060

FLAT-BASE TYPE  
INSULATED PACKAGE

## PRECAUTIONS FOR TESTING

1. Before applying any control supply voltage ( $V_D$ ), the input terminals should be pulled up by resistors, etc. to their corresponding supply voltage and each input signal should be kept off state.  
After this, the specified ON and OFF level setting for each input signal should be done.
2. When performing "SC" tests, the turn-off surge voltage spike at the corresponding protection operation should not be allowed to rise above  $V_{CES}$  rating of the device.  
(These test should not be done by using a curve tracer or its equivalent.)

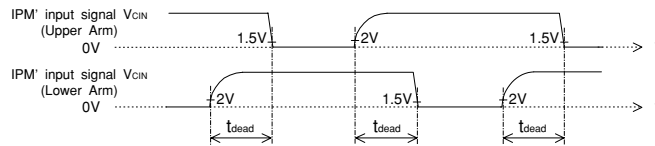
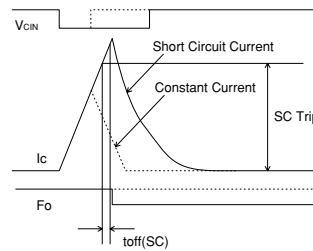
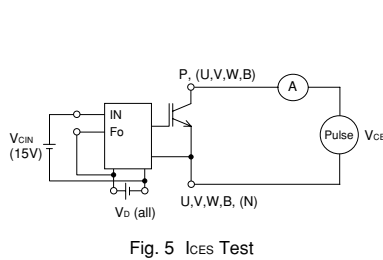
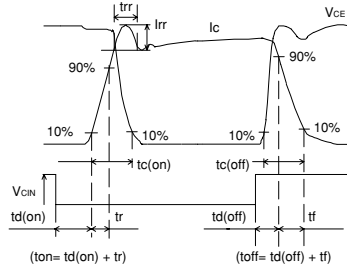
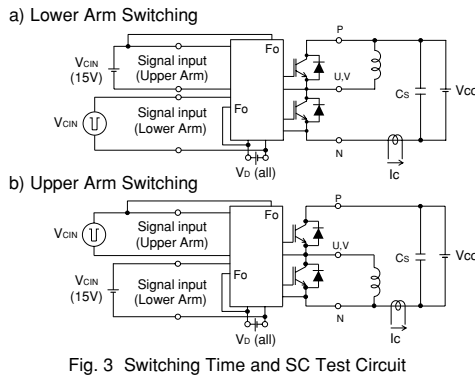
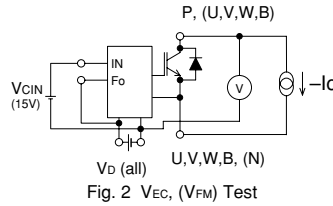
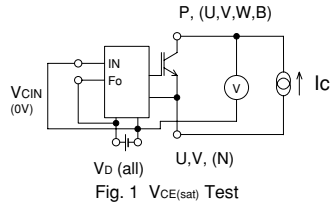

Fig. 7 Dead Time Measurement Point Example

# PM75B6LA060

FLAT-BASE TYPE  
INSULATED PACKAGE

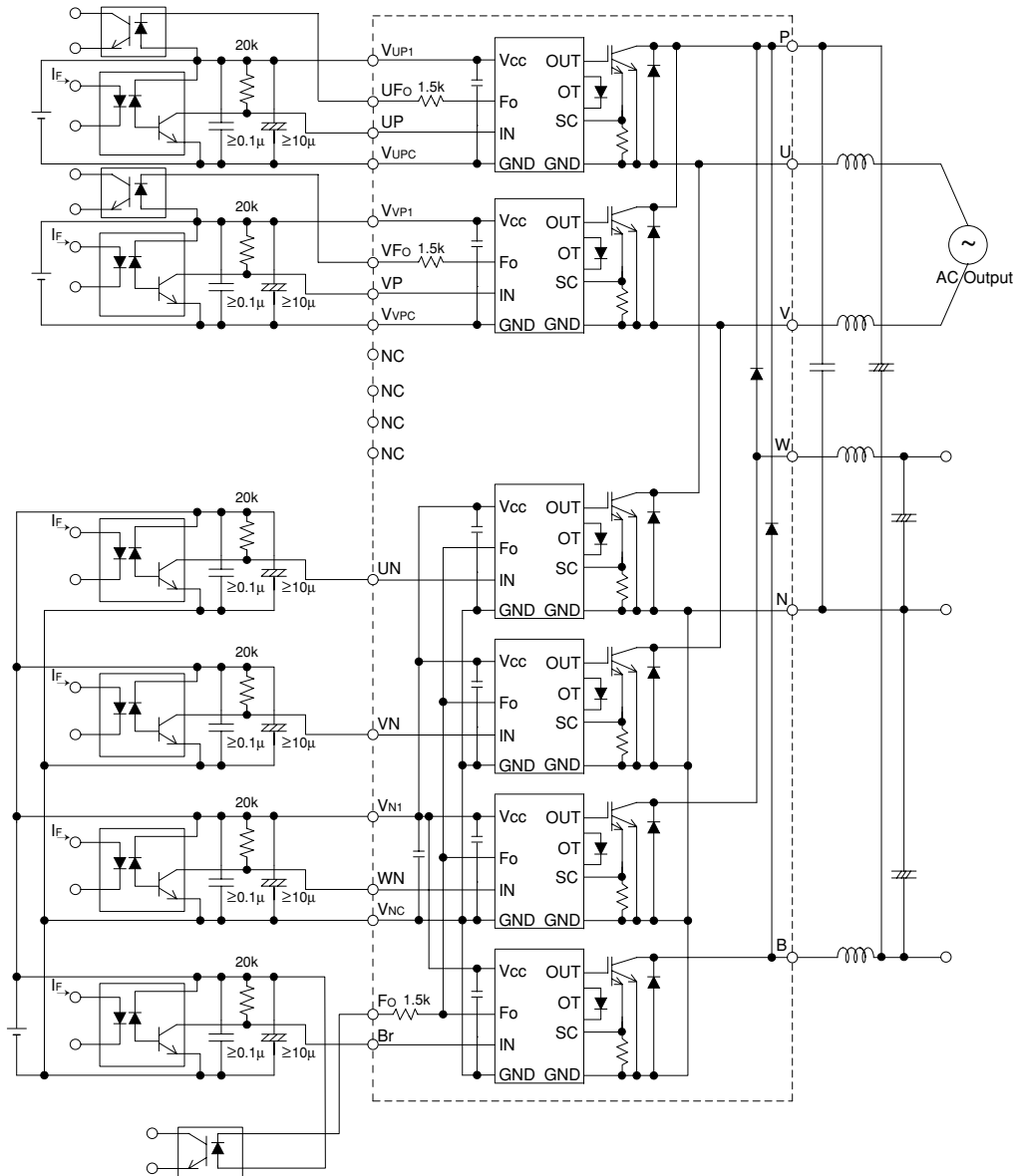

Fig. 8 Application Example Circuit

**NOTES FOR STABLE AND SAFE OPERATION ;**

- Design the PCB pattern to minimize wiring length between opto-coupler and IPM's input terminal, and also to minimize the stray capacity between the input and output wirings of opto-coupler.
- Connect low impedance capacitor between the Vcc and GND terminal of each fast switching opto-coupler.
- Fast switching opto-couplers:  $t_{PLH}, t_{PHL} \leq 0.8\mu s$ , Use High CMR type.
- Slow switching opto-coupler: CTR > 100%
- Use 3 isolated control power supplies (VD). Also, care should be taken to minimize the instantaneous voltage charge of the power supply.
- Make inductance of DC bus line as small as possible, and minimize surge voltage using snubber capacitor between P and N terminal.

**PM75B6LA060**

FLAT-BASE TYPE  
INSULATED PACKAGE

**PERFORMANCE CURVES (INVERTER PART)**

**OUTPUT CHARACTERISTICS (TYPICAL)**

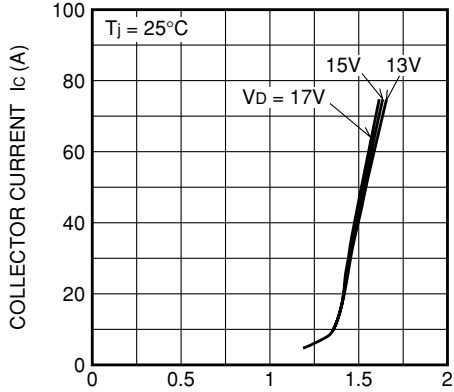

COLLECTOR-EMITTER SATURATION VOLTAGE  $V_{CE(sat)}$  (V)

**COLLECTOR-EMITTER SATURATION VOLTAGE (VS.  $I_c$ ) CHARACTERISTICS (TYPICAL)**

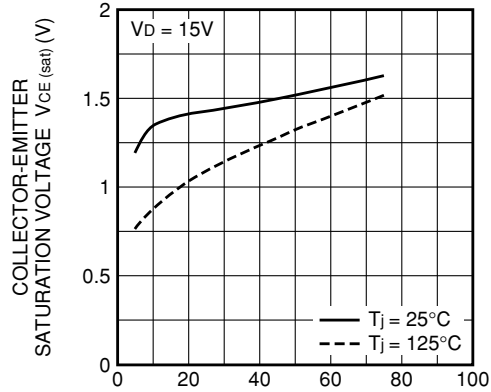

COLLECTOR CURRENT  $I_c$  (A)

**COLLECTOR-EMITTER SATURATION VOLTAGE (VS.  $V_d$ ) CHARACTERISTICS (TYPICAL)**

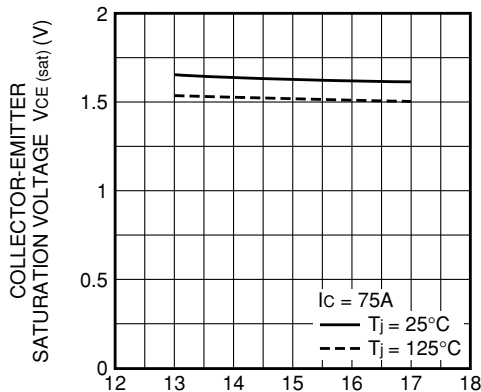

CONTROL SUPPLY VOLTAGE  $V_d$  (V)

**SWITCHING TIME CHARACTERISTICS (TYPICAL)**

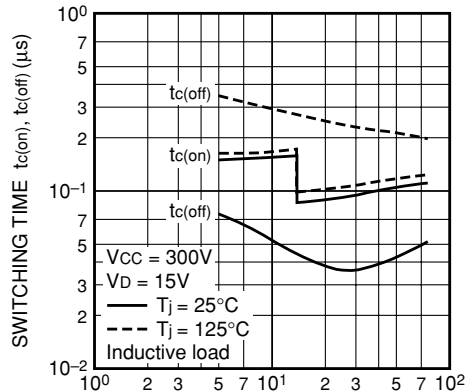

COLLECTOR CURRENT  $I_c$  (A)

**SWITCHING TIME CHARACTERISTICS (TYPICAL)**

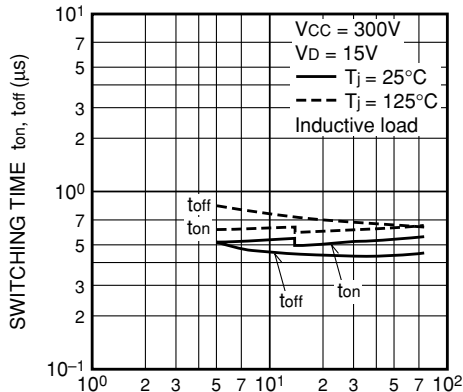

COLLECTOR CURRENT  $I_c$  (A)

**SWITCHING LOSS CHARACTERISTICS (TYPICAL)**

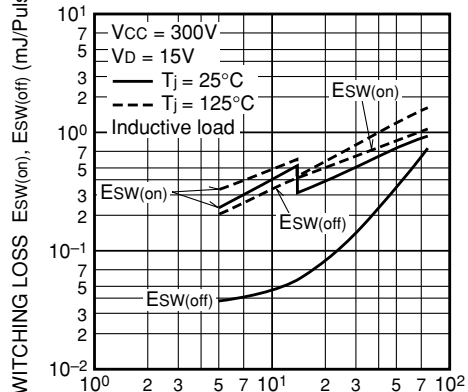

COLLECTOR CURRENT  $I_c$  (A)

PM75B6LA060

FLAT-BASE TYPE  
INSULATED PACKAGE

FWDi FORWARD VOLTAGE CHARACTERISTICS (TYPICAL)

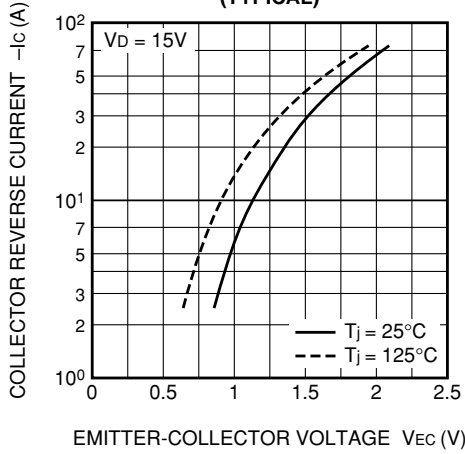

FWDi REVERSE RECOVERY CHARACTERISTICS (TYPICAL)

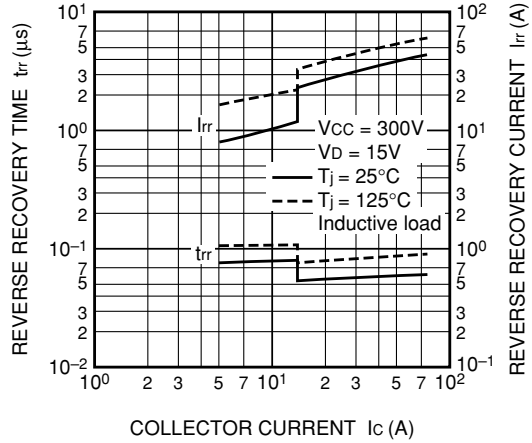

FWDi REVERSE RECOVERY LOSS CHARACTERISTICS (TYPICAL)

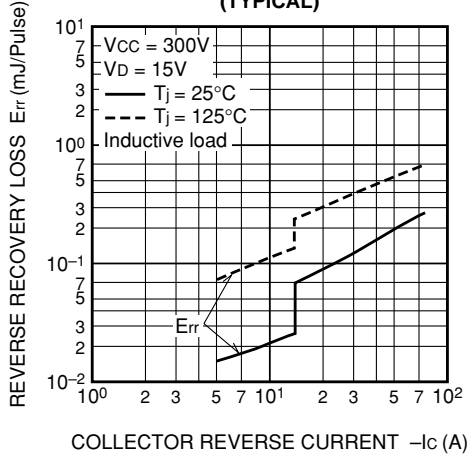

TRANSIENT THERMAL IMPEDANCE CHARACTERISTICS (IGBT PART)

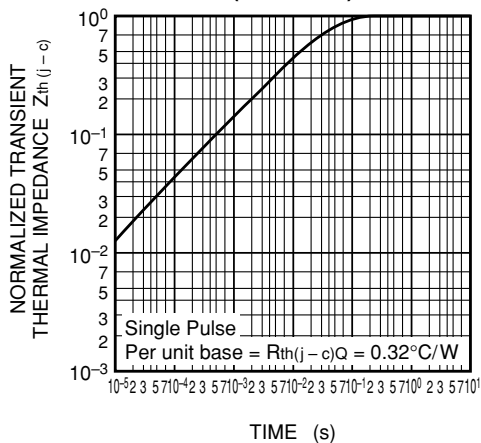

TRANSIENT THERMAL IMPEDANCE CHARACTERISTICS (FWDi PART)

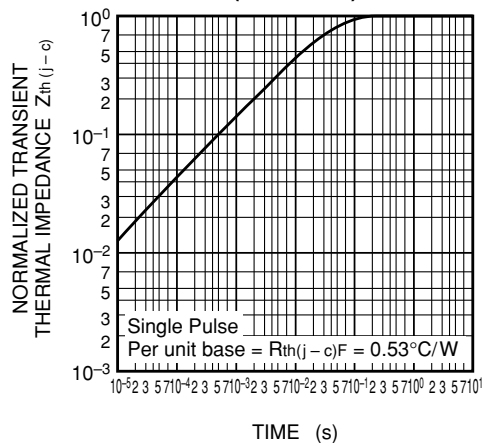



# PM75B6LA060

FLAT-BASE TYPE  
INSULATED PACKAGE

**(CONVERTER PART)**

**OUTPUT CHARACTERISTICS (TYPICAL)**

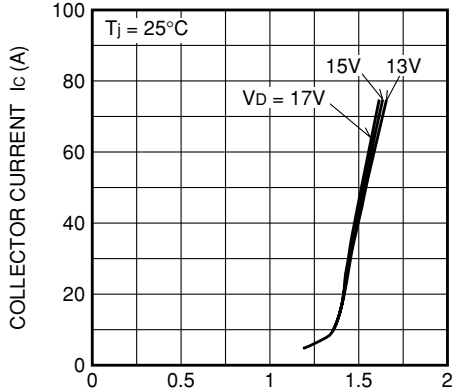

COLLECTOR-EMITTER SATURATION VOLTAGE  $V_{CE(sat)}$  (V)

**COLLECTOR-EMITTER SATURATION VOLTAGE (VS.  $I_c$ ) CHARACTERISTICS (TYPICAL)**

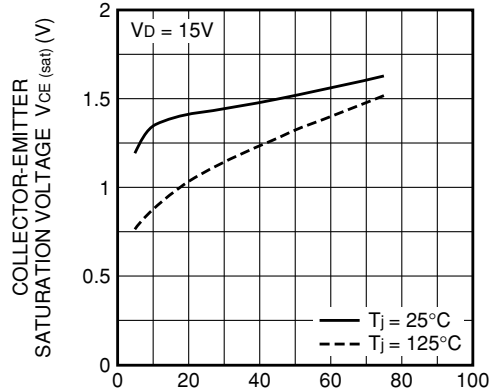

COLLECTOR CURRENT  $I_c$  (A)

**COLLECTOR-EMITTER SATURATION VOLTAGE (VS.  $V_D$ ) CHARACTERISTICS (TYPICAL)**

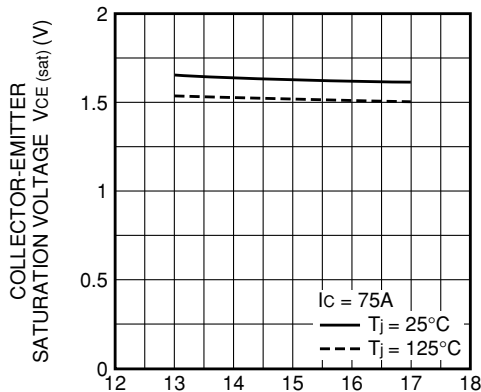

CONTROL SUPPLY VOLTAGE  $V_D$  (V)

**SWITCHING TIME CHARACTERISTICS (Lower Arm - TYPICAL)**

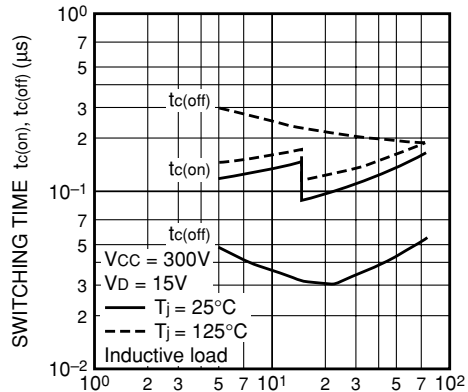

COLLECTOR CURRENT  $I_c$  (A)

**SWITCHING TIME CHARACTERISTICS (Lower Arm - TYPICAL)**

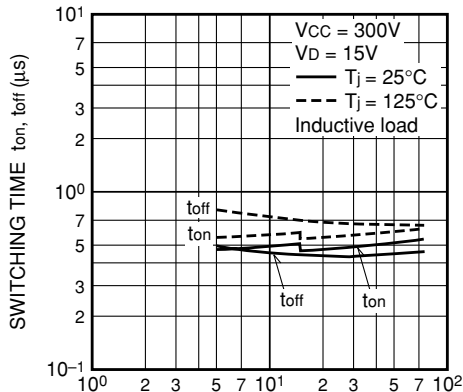

COLLECTOR CURRENT  $I_c$  (A)

**SWITCHING LOSS CHARACTERISTICS (Lower Arm - TYPICAL)**

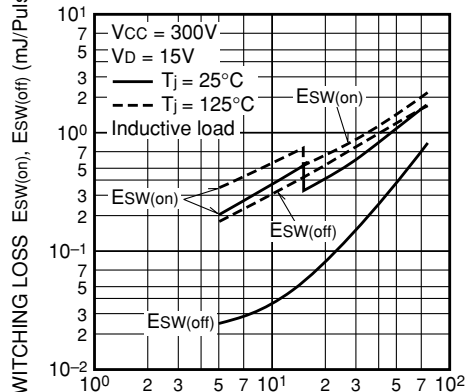

COLLECTOR CURRENT  $I_c$  (A)

PM75B6LA060

FLAT-BASE TYPE  
INSULATED PACKAGE

FWDi FORWARD VOLTAGE CHARACTERISTICS  
(Upper Arm - TYPICAL)

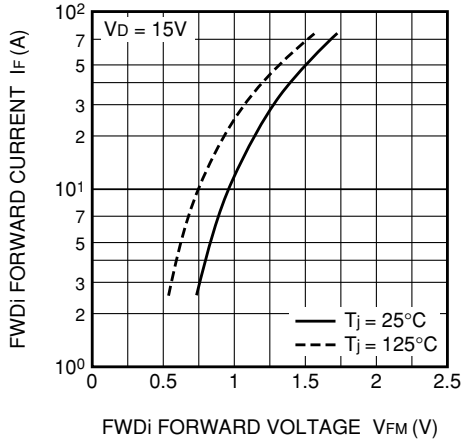

FWDi REVERSE RECOVERY CHARACTERISTICS  
(Upper Arm - TYPICAL)

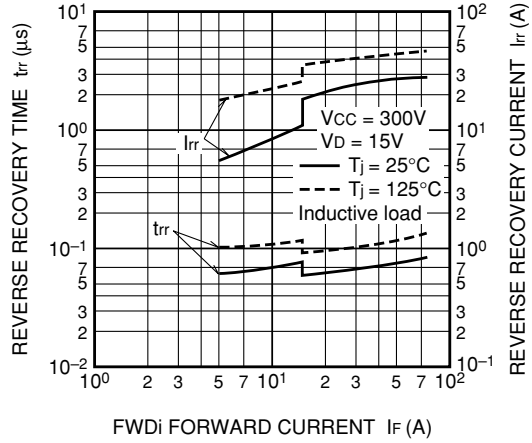

FWDi REVERSE RECOVERY LOSS CHARACTERISTICS  
(Upper Arm - TYPICAL)

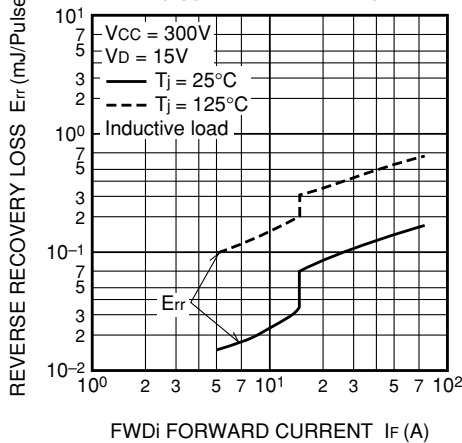

TRANSIENT THERMAL  
IMPEDANCE CHARACTERISTICS  
(IGBT PART)

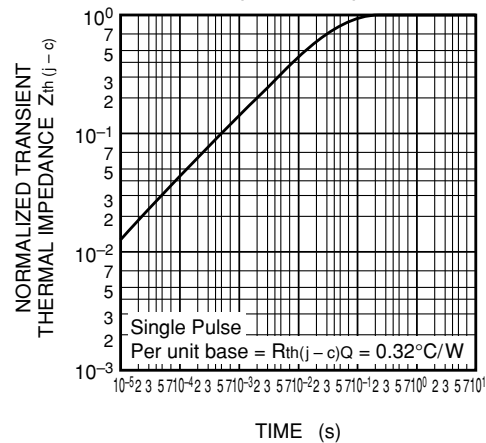

TRANSIENT THERMAL  
IMPEDANCE CHARACTERISTICS  
(FWDi PART - Upper Arm)

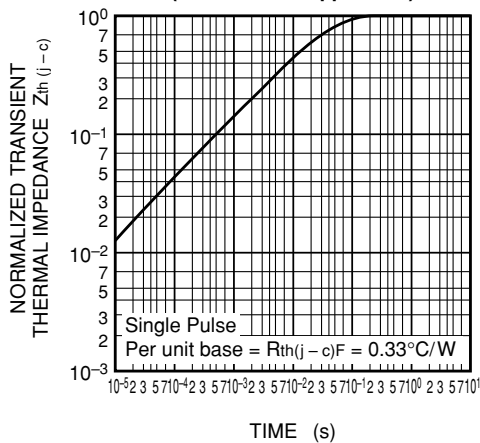

TRANSIENT THERMAL  
IMPEDANCE CHARACTERISTICS  
(FWDi PART - Lower Arm)

