

PM75B6L1C060

FLAT-BASE TYPE
INSULATED PACKAGE

PM75B6L1C060

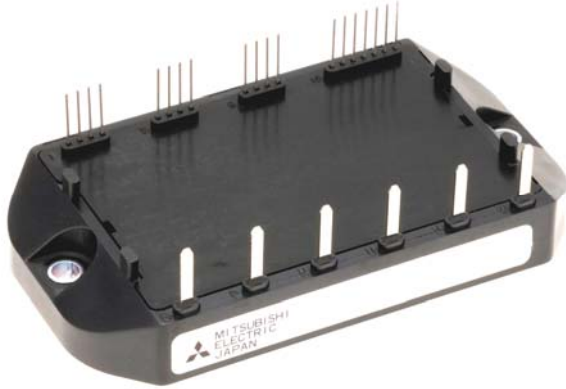

FEATURE

- a) Adopting new 5th generation Full-Gate CSTBT™ chip
- b) Error output signal is possible from all each protection upper and lower IGBT
- c) The mounting surface is 90mm×50mm about 30% less than B6LA type

- Monolithic gate drive & protection logic
- Detection, protection & status indication circuits for, short-circuit, over-temperature & under-voltage

APPLICATION

Photo voltaic power conditioner

PACKAGE OUTLINES

Dimensions in mm

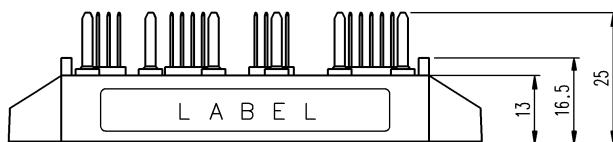
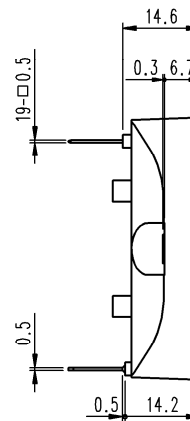
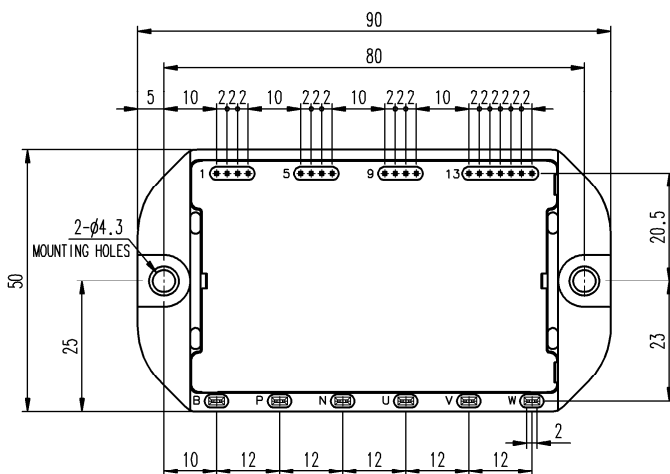

Terminal code

1. VUPC	8. VVP1	15. Br
2. UFo	9. NC	16. UN
3. UP	10. NC	17. VN
4. VUP1	11. NC	18. WN
5. VVPC	12. NC	19. Fo
6. VFo	13. VNC	
7. VP	14. VN1	

PM75B6L1C060

**FLAT-BASE TYPE
INSULATED PACKAGE**

INTERNAL FUNCTIONS BLOCK DIAGRAM

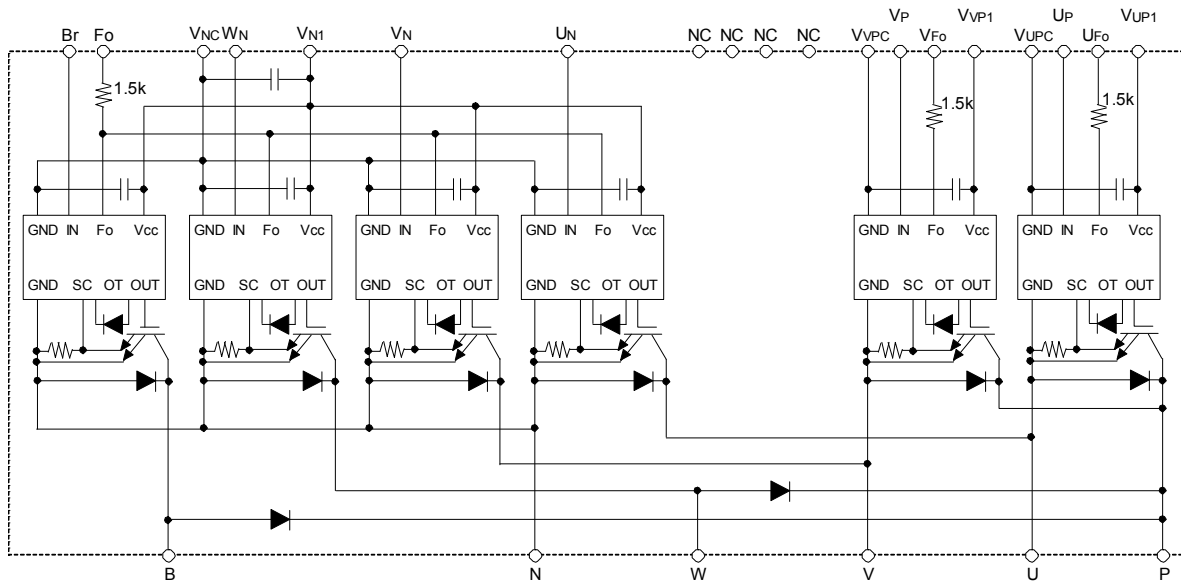

MAXIMUM RATINGS ($T_j = 25^\circ\text{C}$, unless otherwise noted)

INVERTER PART

Symbol	Parameter	Conditions	Ratings	Unit
V_{CES}	Collector-Emitter Voltage	$V_D=15\text{V}, V_{CIN}=15\text{V}$	600	V
I_C	Collector Current	$T_c=25^\circ\text{C}$	75	A
I_{CRM}		Pulse	150	
P_{tot}	Total Power Dissipation	$T_c=25^\circ\text{C}$	201	W
I_E	Emitter Current	$T_c=25^\circ\text{C}$	75	A
I_{ERM}	(Free wheeling Diode Forward current)	Pulse	150	
T_j	Junction Temperature		-20 ~ +150	$^\circ\text{C}$

*: T_c measurement point is just under the chip.

CONVERTER PART

Symbol	Parameter	Conditions	Ratings	Unit
V_{CES}	Collector-Emitter Voltage	$V_D=15\text{V}, V_{CIN}=15\text{V}$	600	V
I_C	Collector Current	$T_c=25^\circ\text{C}$	75	A
I_{CRM}		Pulse	150	
P_{tot}	Total Power Dissipation	$T_c=25^\circ\text{C}$	201	W
I_E	Emitter Current	$T_c=25^\circ\text{C}$	75	A
I_{ERM}	(Free wheeling Diode Forward current)	Pulse	150	
I_F	Di Forward Current	$T_c=25^\circ\text{C}$	75	A
$V_{R(DC)}$	Di Rated DC Reverse Voltage	$T_c=25^\circ\text{C}$	600	V
T_j	Junction Temperature		-20 ~ +150	$^\circ\text{C}$

*: T_c measurement point is just under the chip.

PM75B6L1C060

FLAT-BASE TYPE
INSULATED PACKAGE

CONTROL PART

Symbol	Parameter	Conditions	Ratings	Unit
V_D	Supply Voltage	Applied between : $V_{UP1}-V_{UPC}$, $V_{VP1}-V_{VPC}$, $V_{N1}-V_{NC}$	20	V
V_{CIN}	Input Voltage	Applied between : $UP-V_{UPC}$, $VP-V_{VPC}$, $UN \cdot VN \cdot WN \cdot Br-V_{NC}$	20	V
V_{FO}	Fault Output Supply Voltage	Applied between : $UFo-V_{UPC}$, $VFo-V_{VPC}$, $Fo-V_{NC}$	20	V
I_{FO}	Fault Output Current	Sink current at UFo , VFo , Fo terminals	20	mA

TOTAL SYSTEM

Symbol	Parameter	Conditions	Ratings	Unit
$V_{CC(Prot)}$	Supply Voltage Protected by SC	$V_D = 13.5V \sim 16.5V$ Inverter Part, $T_J = +125^\circ C$ Start	450	V
$V_{CC(surge)}$	Supply Voltage (Surge)	Applied between : P-N, Surge value	500	V
T_{stg}	Storage Temperature		-40 ~ +125	$^\circ C$
V_{isol}	Isolation Voltage	60Hz, Sinusoidal, RMS, Charged part to Base, AC 1min.	2500	V

*: T_C measurement point is just under the chip.

THERMAL RESISTANCE

Symbol	Parameter	Conditions	Limits			Unit
			Min.	Typ.	Max.	
$R_{th(j-c)Q}$	Thermal Resistance	Inverter, IGBT (per 1 element) (Note.1)	-	-	0.62	K/W
$R_{th(j-c)D}$		Inverter, FWDi (per 1 element) (Note.1)	-	-	1.06	
$R_{th(j-c)Q}$		Converter, IGBT (per 1 element) (Note.1)	-	-	0.62	
$R_{th(j-c)D}$		Converter, FWDi (per 1 element) (Note.1)	-	-	1.06	
$R_{th(j-c)D}$		Converter, Di (per 1 element) (Note.1)	-	-	1.06	
$R_{th(c-s)}$	Contact Thermal Resistance	Case to heat sink, (per 1 module) Thermal grease applied (Note.1)	-	0.06	-	

Note.1: If you use this value, $R_{th(s-a)}$ should be measured just under the chips.

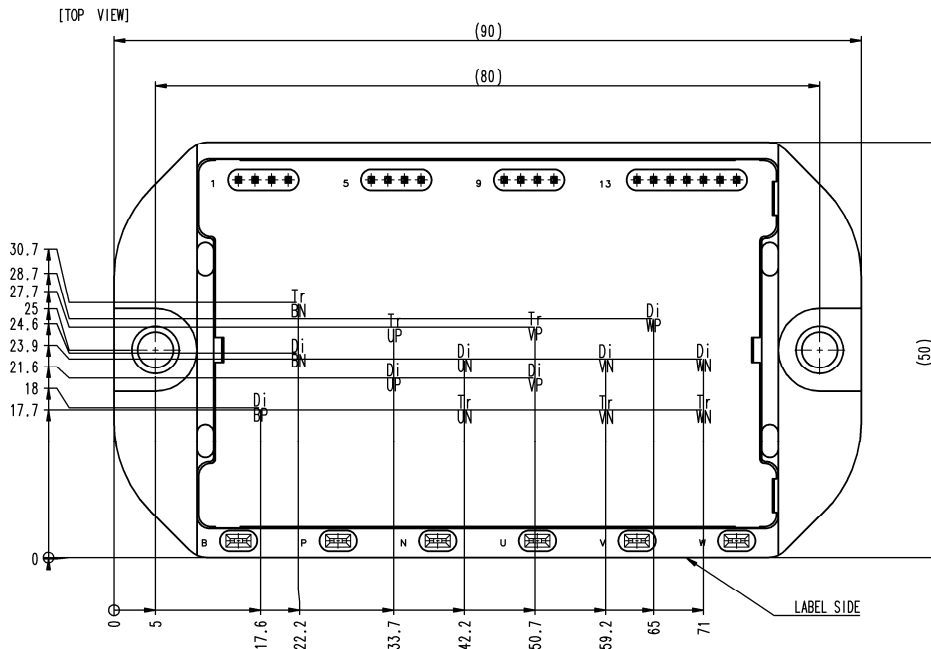

PM75B6L1C060

**FLAT-BASE TYPE
INSULATED PACKAGE**

ELECTRICAL CHARACTERISTICS (T_j = 25°C, unless otherwise noted)

INVERTER PART

Symbol	Parameter	Conditions	Limits			Unit	
			Min.	Typ.	Max.		
V _{CEsat}	Collector-Emitter Saturation Voltage	V _D =15V, I _C =75A V _{CIN} =0V, Pulsed (Fig. 1)	T _j =25°C	-	2.2	2.7	V
			T _j =125°C	-	2.2	2.7	
V _{EC}	Emitter-Collector Voltage	I _E =75A, V _D =15V, V _{CIN} = 15V (Fig. 2)	-	2.4	3.3	V	
t _{on}	Switching Time	V _D =15V, V _{CIN} =0V↔15V V _{CC} =300V, I _C =75A T _j =125°C Inductive Load (Fig. 3,4)	-	0.1	0.5	1.2	μs
t _{rr}			-	-	0.1	0.2	
t _{c(on)}			-	-	0.15	0.3	
t _{off}			-	-	1.1	2.0	
t _{c(off)}			-	-	0.2	0.4	
I _{CES}	Collector-Emitter Cut-off Current	V _{CE} =V _{CES} , V _D =15V, V _{CIN} =15V (Fig. 5)	T _j =25°C	-	-	1	mA
			T _j =125°C	-	-	10	

CONVERTER PART

Symbol	Parameter	Conditions	Limits			Unit	
			Min.	Typ.	Max.		
V _{CEsat}	Collector-Emitter Saturation Voltage	V _D =15V, I _C =75A V _{CIN} =0V, Pulsed (Fig. 1)	T _j =25°C	-	2.2	2.7	V
			T _j =125°C	-	2.2	2.7	
V _{EC}	Emitter-Collector Voltage	I _E =75A, V _D =15V, V _{CIN} = 15V (Fig. 2)	-	2.4	3.3	V	
V _{FM}	Di Forward Voltage	I _F =75A	-	2.4	3.3	V	
t _{on}	Switching Time	V _D =15V, V _{CIN} =0V↔15V V _{CC} =300V, I _C =75A T _j =125°C Inductive Load (Fig. 3,4)	-	0.1	0.5	1.2	μs
t _{rr}			-	-	0.1	0.2	
t _{c(on)}			-	-	0.15	0.3	
t _{off}			-	-	1.1	2.0	
t _{c(off)}			-	-	0.2	0.4	
I _{CES}	Collector-Emitter Cut-off Current	V _{CE} =V _{CES} , V _D =15V, V _{CIN} =15V (Fig. 5)	T _j =25°C	-	-	1	mA
			T _j =125°C	-	-	10	

CONTROL PART

Symbol	Parameter	Conditions	Limits			Unit	
			Min.	Typ.	Max.		
I _D	Circuit Current	V _D =15V, V _{CIN} =15V	V _{N1} -V _{NC}	-	6.5	12	mA
			V _{P1} -V _{PC}	-	1.6	4.0	
V _{th(ON)}	Input ON Threshold Voltage	Applied between : UP-V _{UPC} , VP-V _{VPC} , UN·VN·WN·Br -V _{NC}	-	1.2	1.5	1.8	V
V _{th(OFF)}	Input OFF Threshold Voltage		-	1.7	2.0	2.3	
SC	Short Circuit Trip Level	-20≤T _j ≤125°C, V _D =15V (Fig. 3, 6)	112	-	-	A	
t _{off(SC)}	Short Circuit Current Delay Time	V _D =15V (Fig. 3, 6)	-	0.2	-	μs	
OT	Over Temperature Protection	Detect Temperature of IGBT chip	Trip level	135	-	-	°C
OT _(hys)			Hysteresis	-	20	-	
UV _t	Supply Circuit Under-Voltage Protection	-20≤T _j ≤125°C	Trip level	11.5	12.0	12.5	V
UV _r			Reset level	-	12.5	-	
I _{FO(H)}	Fault Output Current	V _D =15V, V _{FO} =15V (Note.2)	-	-	0.01	mA	
I _{FO(L)}			-	10	15		
t _{FO}	Fault Output Pulse Width	V _D =15V (Note.2)	1.0	1.8	-	ms	

Note.2: Fault output is given only when the internal SC, OT & UV protections schemes of either upper or lower arm device operate to protect it.

PM75B6L1C060

**FLAT-BASE TYPE
INSULATED PACKAGE**

MECHANICAL RATINGS AND CHARACTERISTICS

Symbol	Parameter	Conditions	Limits			Unit
			Min.	Typ.	Max.	
M_t	Mounting Torque	Mounting part screw : M4	1.4	1.65	1.9	N·m
m	Weight	-	-	135	-	g

RECOMMENDED CONDITIONS FOR USE

Symbol	Parameter	Conditions	Recommended value	Unit
V_{CC}	Supply Voltage	Applied across P-N terminals	≤ 450	V
V_D	Control Supply Voltage	Applied between : $V_{UP1}-V_{UPC}$, $V_{VP1}-V_{VPC}$; $V_{N1}-V_{NC}$ (Note.3)	15.0 ± 1.5	V
$V_{CIN(ON)}$	Input ON Voltage	Applied between : $UP-V_{UPC}$, $VP-V_{VPC}$, $UN \cdot VN \cdot WN \cdot Br -V_{NC}$	≤ 0.8	V
$V_{CIN(OFF)}$	Input OFF Voltage		≥ 9.0	
f_{PWM}	PWM Input Frequency	Using Application Circuit of Fig. 8	≤ 20	kHz
t_{dead}	Arm Shoot-through Blocking Time	For IPM's each input signals (Fig. 7)	≥ 2.0	μs
I_o	Module Operating Current	RMS	≤ 30	A

Note.3: With ripple satisfying the following conditions: dv/dt swing $\leq \pm 5V/\mu s$, Variation $\leq 2V$ peak to peak

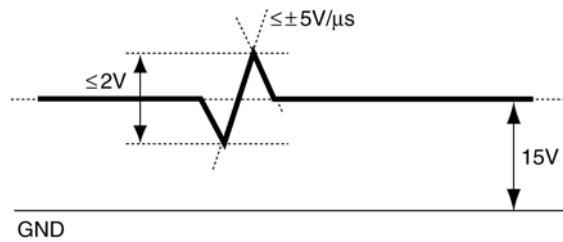

PM75B6L1C060

FLAT-BASE TYPE
INSULATED PACKAGE

PRECAUTIONS FOR TESTING

1. Before applying any control supply voltage (V_D), the input terminals should be pulled up by resistors, etc. to their corresponding supply voltage and each input signal should be kept off state.
After this, the specified ON and OFF level setting for each input signal should be done.
2. When performing "SC" tests, the turn-off surge voltage spike at the corresponding protection operation should not be allowed to rise above V_{CES} rating of the device.
(These test should not be done by using a curve tracer or its equivalent.)

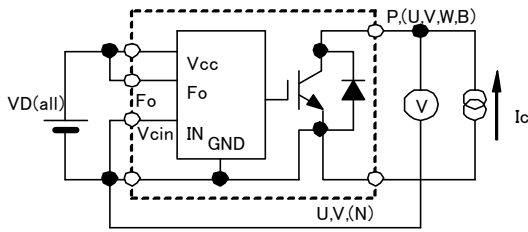

Fig. 1 V_{CESat} Test

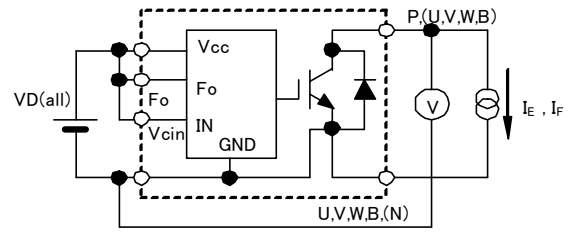

Fig. 2 V_{EC} , V_{FM} Test

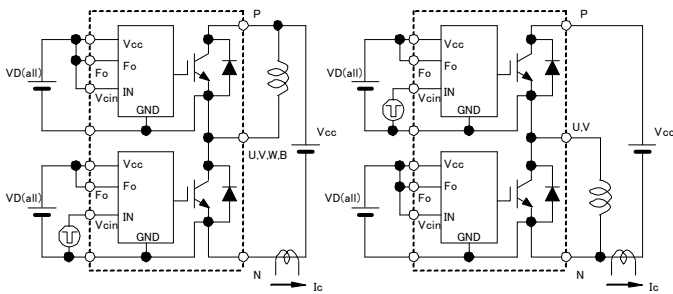

Fig. 3 Switching time and SC test circuit

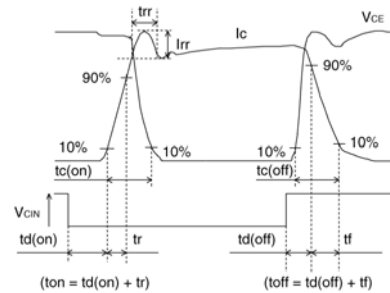

Fig. 4 Switching time test waveform

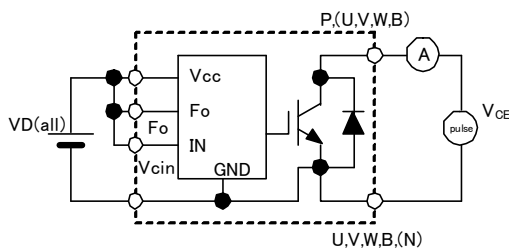

Fig. 5 I_{CES} Test

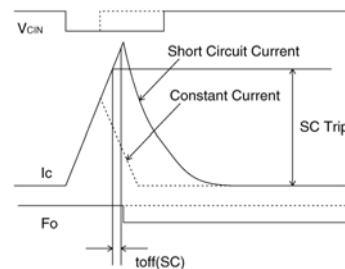
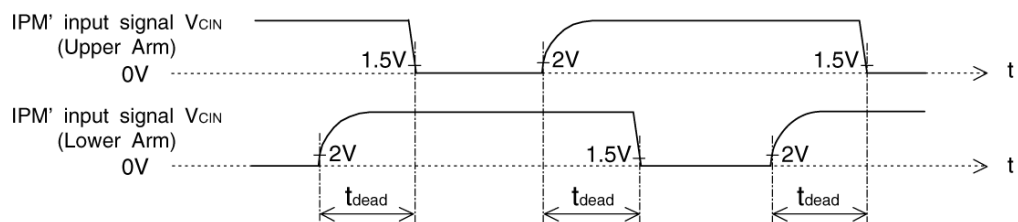

Fig. 6 SC test waveform



1.5V: Input on threshold voltage $V_{th(on)}$ typical value, 2V: Input off threshold voltage $V_{th(off)}$ typical value

Fig. 7 Dead time measurement point example

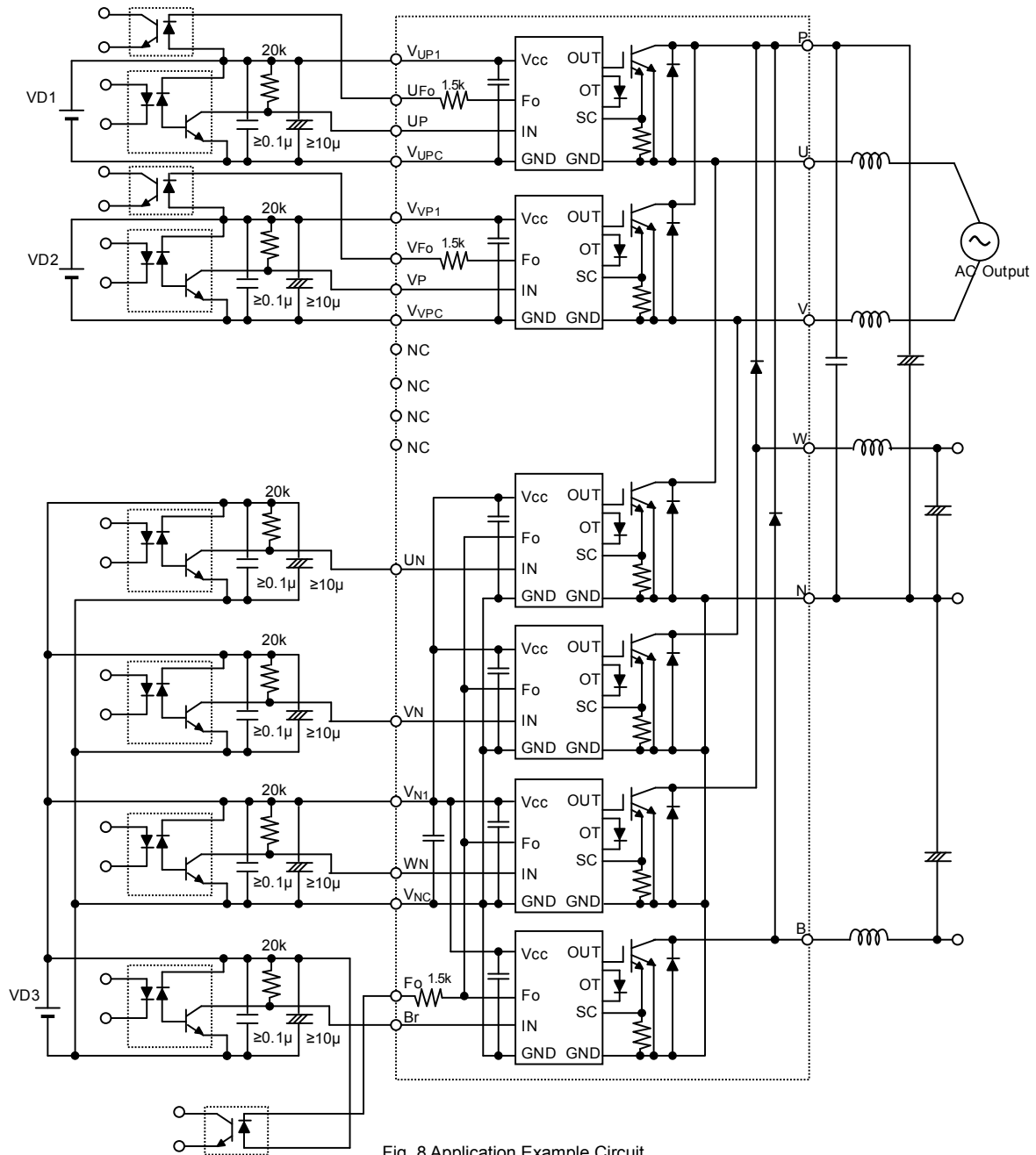

Fig. 8 Application Example Circuit

NOTES FOR STABLE AND SAFE OPERATION ;

- Design the PCB pattern to minimize wiring length between opto-coupler and IPM's input terminal, and also to minimize the stray capacity between the input and output wirings of opto-coupler.
- Connect low impedance capacitor between the Vcc and GND terminal of each fast switching opto-coupler.
- Fast switching opto-couplers: $t_{PLH}, t_{PHL} \leq 0.8\mu s$, Use High CMR type.
- Slow switching opto-coupler: CTR > 100%
- Use 3 isolated control power supplies (V_D). Also, care should be taken to minimize the instantaneous voltage charge of the power supply.
- Make inductance of DC bus line as small as possible, and minimize surge voltage using snubber capacitor between P and N terminal.

PERFORMANCE CURVES

OUTPUT CHARACTERISTICS

(TYPICAL)

INVERTER PART & CONVERTER PART

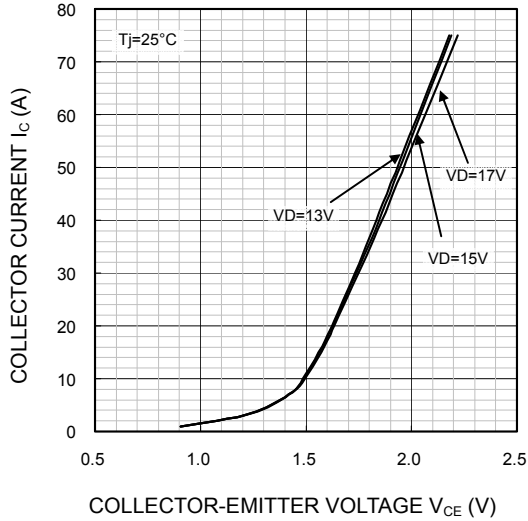

COLLECTOR-EMITTER SATURATION

VOLTAGE (VS. I_c) CHARACTERISTICS

(TYPICAL)

INVERTER PART & CONVERTER PART

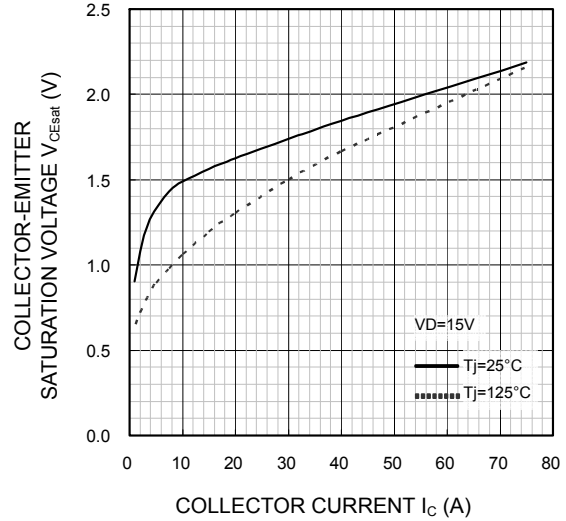

COLLECTOR-EMITTER SATURATION

VOLTAGE (VS. V_D) CHARACTERISTICS

(TYPICAL)

INVERTER PART & CONVERTER PART

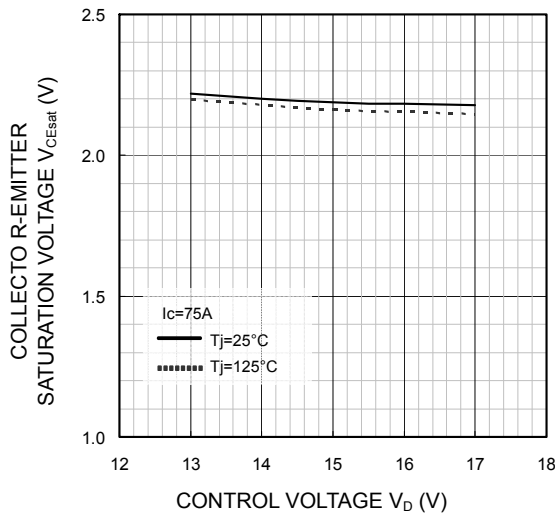

FREE WHEELING DIODE & DIODE

FORWARD CHARACTERISTICS

(TYPICAL)

INVERTER PART & CONVERTER PART

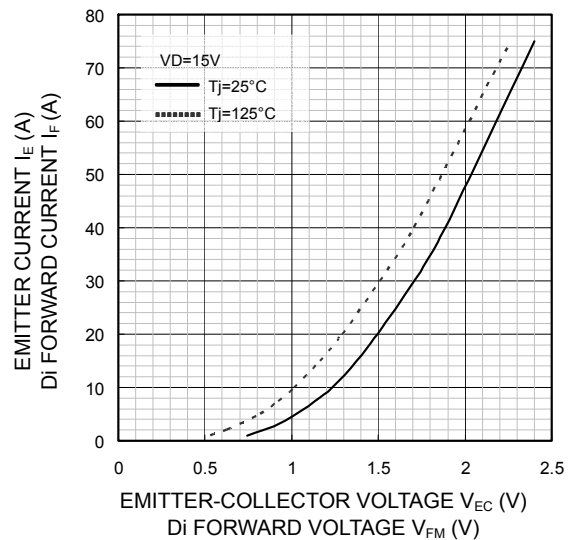

PM75B6L1C060

FLAT-BASE TYPE
INSULATED PACKAGE

SWITCHING TIME (t_{on} , t_{off}) CHARACTERISTICS
(TYPICAL)

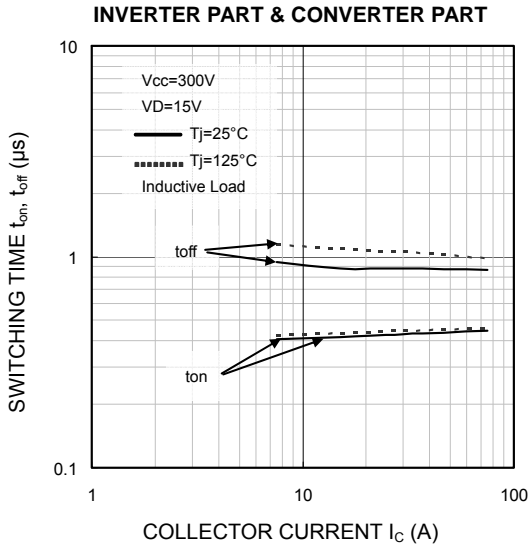

SWITCHING TIME ($t_{c(on)}$, $t_{c(off)}$) CHARACTERISTICS
(TYPICAL)

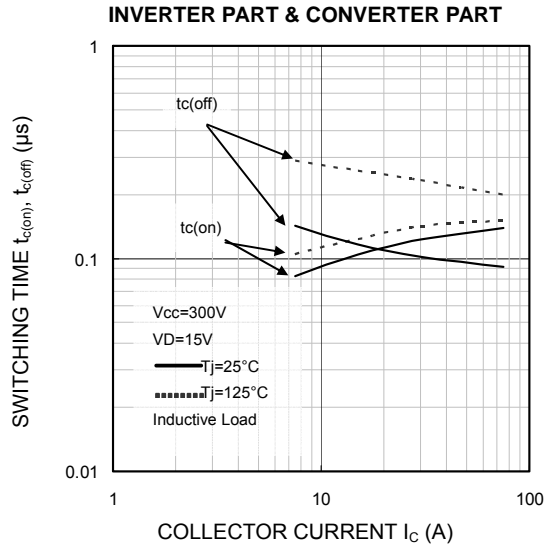

SWITCHING ENERGY CHARACTERISTICS
(TYPICAL)
INVERTER PART

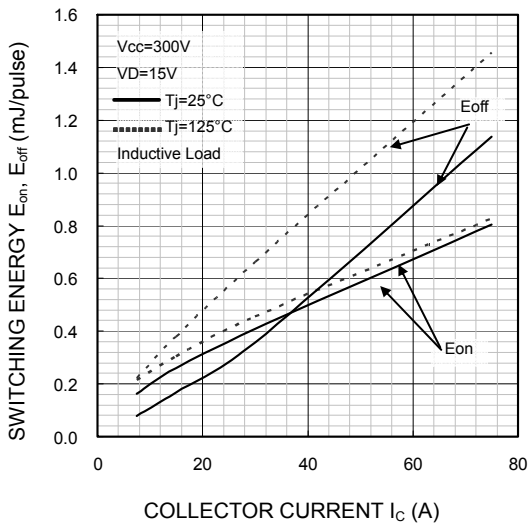

SWITCHING ENERGY CHARACTERISTICS
(TYPICAL)
CONVERTER PART

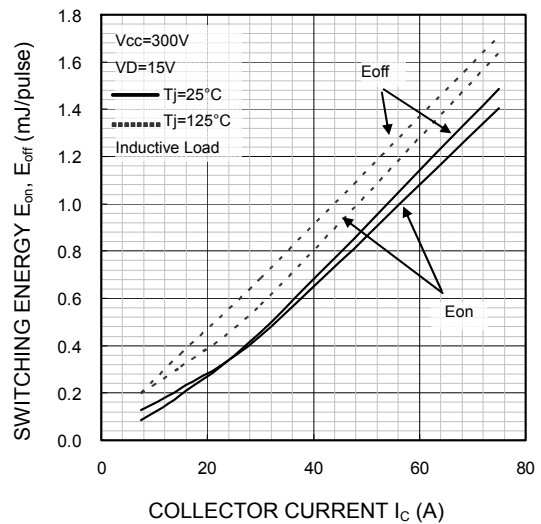

PM75B6L1C060

FLAT-BASE TYPE
INSULATED PACKAGE

FREE WHEELING DIODE
REVERSE RECOVERY CHARACTERISTICS
(TYPICAL)
INVERTER PART

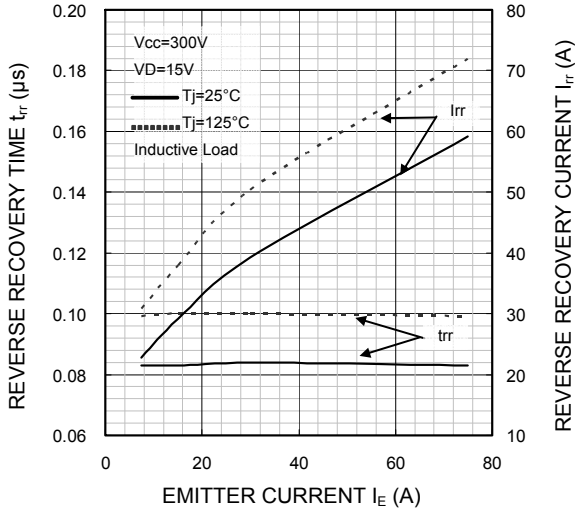

FREE WHEELING DIODE
REVERSE RECOVERY CHARACTERISTICS
(TYPICAL)
CONVERTER PART

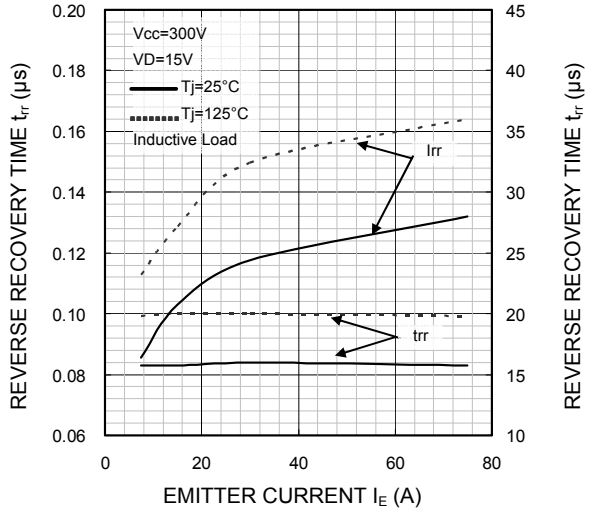

FREE WHEELING DIODE
REVERSE RECOVERY ENERGY
CHARACTERISTICS
(TYPICAL)
INVERTER PART

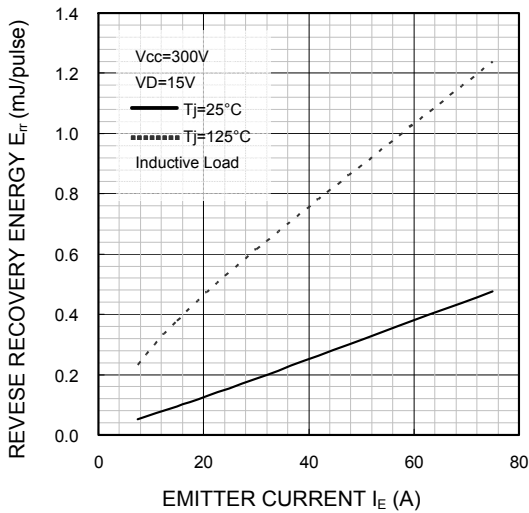

FREE WHEELING DIODE
REVERSE RECOVERY ENERGY
CHARACTERISTICS
(TYPICAL)
CONVERTER PART

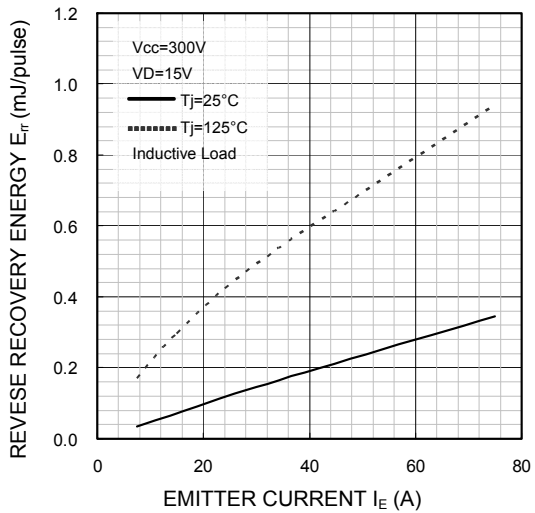

PM75B6L1C060

FLAT-BASE TYPE
INSULATED PACKAGE

**I_D VS. f_c CHARACTERISTICS
(TYPICAL)**

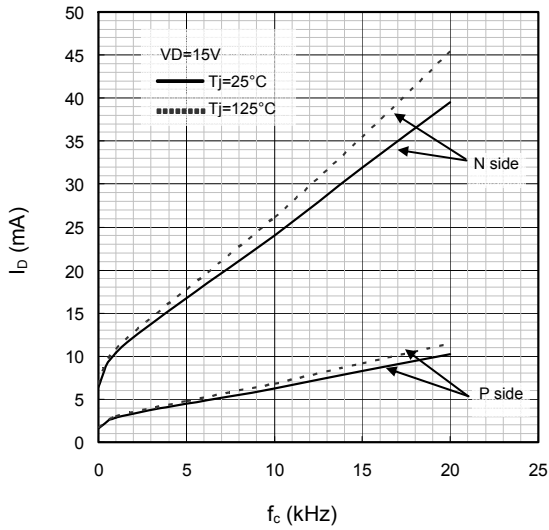

**UV TRIP LEVEL VS. T_j CHARACTERISTICS
(TYPICAL)**

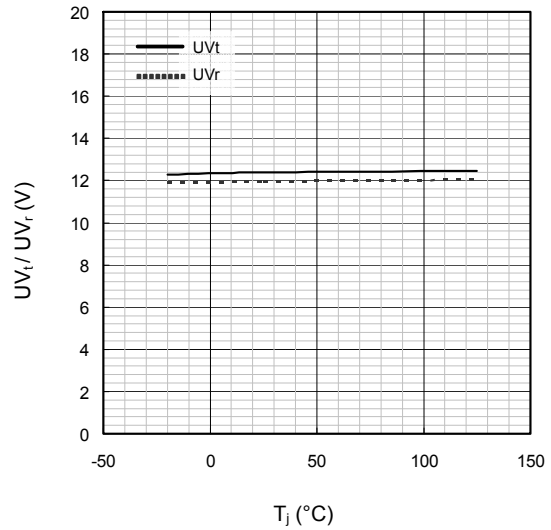

**SC TRIP LEVEL VS. T_j CHARACTERISTICS
(TYPICAL)**
INVERTER PART & CONVERTER PART

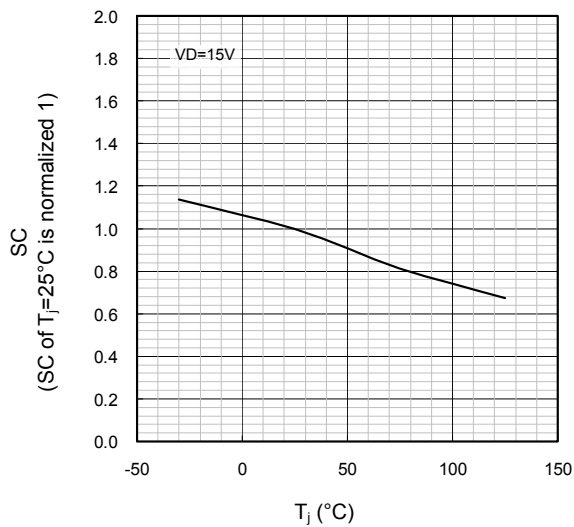

PM75B6L1C060

**FLAT-BASE TYPE
INSULATED PACKAGE**

**TRANSIENT THERMAL
IMPEDANCE CHARACTERISTICS
INVERTER PART**

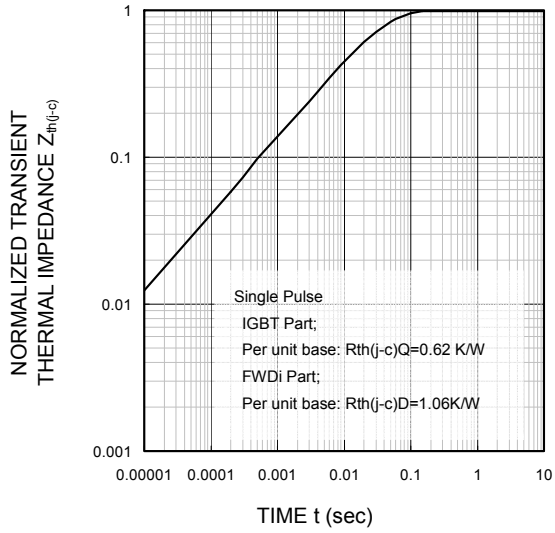

**TRANSIENT THERMAL
IMPEDANCE CHARACTERISTICS
CONVERTER PART**

