

## Fuji Discrete Package IGBT

### ■ Features

- Square RBSOA
- Low Saturation Voltage
- Less Total Power Dissipation
- Minimized Internal Stray Inductance

### ■ Applications

- High Power Switching
- A.C. Motor Controls
- D.C. Motor Controls
- Uninterruptible Power Supply

## ■ Outline Drawing

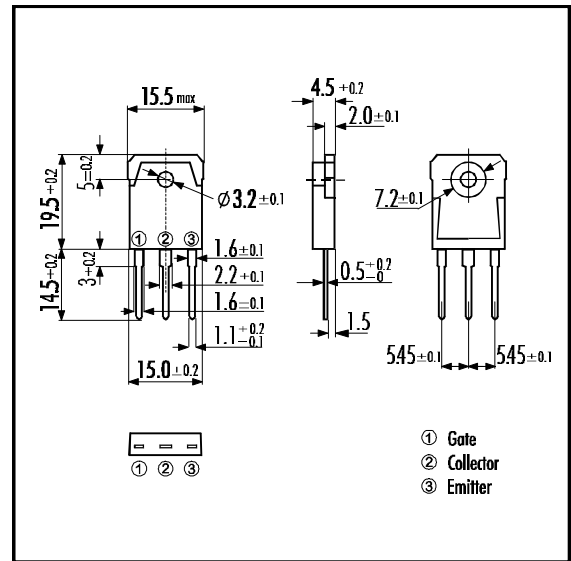

## ■ Maximum Ratings and Characteristics

### • Absolute Maximum Ratings ( $T_c=25^\circ\text{C}$ )

Items	Symbols	Ratings	Units
Collector-Emitter Voltage	$V_{CES}$	600	V
Gate -Emitter Voltage	$V_{GES}$	$\pm 20$	V
Collector Current	DC $T_c=25^\circ\text{C}$	$I_{C25}$	48
	DC $T_c=80^\circ\text{C}$	$I_{C80}$	30
	1ms $T_c=25^\circ\text{C}$	$I_{CPULSE}$	192
IGBT Max. Power Dissipation	$P_C$	180	W
Operating Temperature	$T_j$	+150	$^\circ\text{C}$
Storage Temperature	$T_{stg}$	-40 ~ +150	$^\circ\text{C}$
Mounting Screw Torque		50	Nm

## ■ Equivalent Circuit

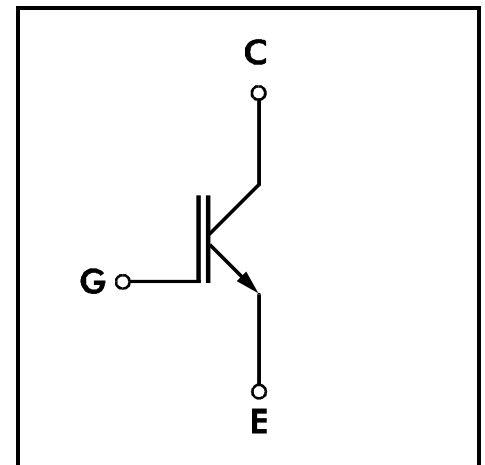

### • Electrical Characteristics ( at $T_F=25^\circ\text{C}$ )

Items	Symbols	Test Conditions	Min.	Typ.	Max.	Units		
Zero Gate Voltage Collector Current	$I_{CES}$	$V_{GE}=0V$ $V_{CE}=600V$			1.0	mA		
Gate-Emitter Leakage Current	$I_{GES}$	$V_{CE}=0V$ $V_{GE}=\pm 20V$			20	$\mu\text{A}$		
Gate-Emitter Threshold Voltage	$V_{GE(th)}$	$V_{GE}=20V$ $I_C=30\text{mA}$	5.5		8.5	V		
Collector-Emitter Saturation Voltage	$V_{CE(sat)}$	$V_{GE}=15V$ $I_C=30\text{A}$			3.0	V		
Input capacitance	$C_{ies}$	$V_{GE}=0V$		1900		pF		
Output capacitance	$C_{oes}$	$V_{CE}=10V$		400				
Reverse Transfer capacitance	$C_{res}$	$f=1\text{MHz}$		100				
Switching Time	Turn-on Time	$t_{ON}$	$V_{CC}=300V$			1.2	$\mu\text{s}$	
		$t_r$	$I_C=30\text{A}$			0.6		
	Turn-off Time	$t_{OFF}$	$V_{GE}=\pm 15V$			1.0		
		$t_f$	$R_G=82\Omega$			0.35		
	Turn-on Time	$t_{ON}$	$V_{CC}=300V$		0.16		$\mu\text{s}$	
		$t_r$	$I_C=30\text{A}$		0.11			
		Turn-off Time	$t_{OFF}$	$V_{GE}=+15V$		0.30		
			$t_f$	$R_G=8\Omega$				0.35

### • Thermal Characteristics

Items	Symbols	Test Conditions	Min.	Typ.	Max.	Units
Thermal Resistance	$R_{th(j-c)}$				0.69	$^\circ\text{C/W}$

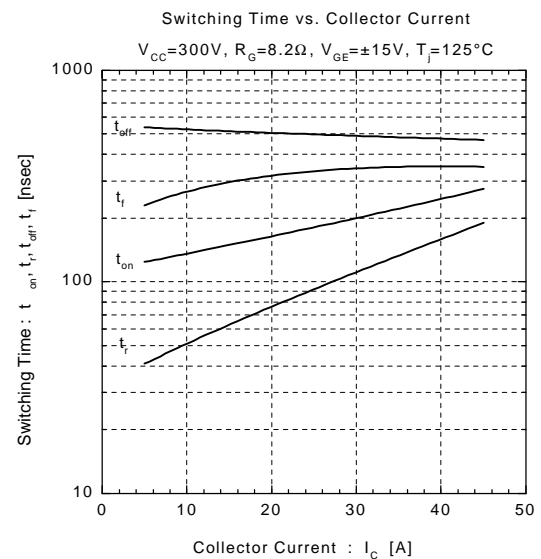
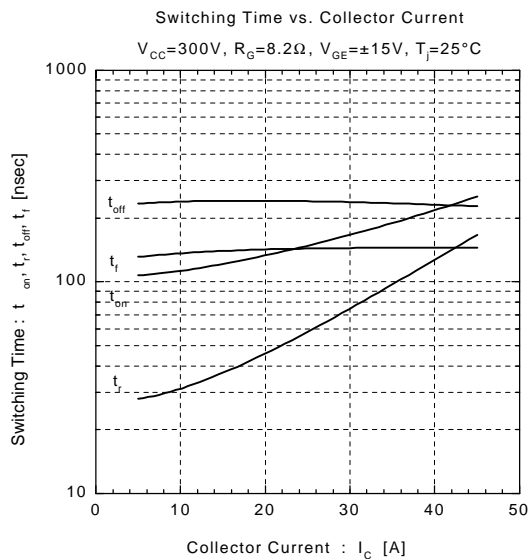
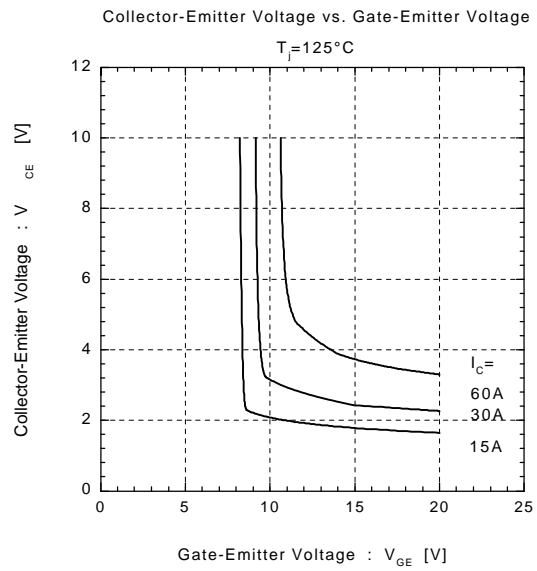
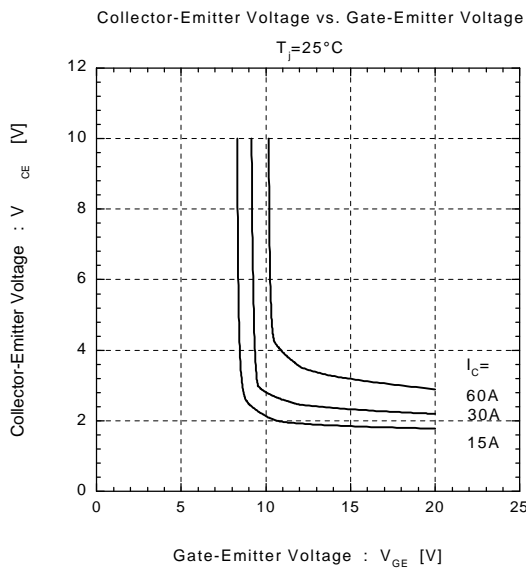
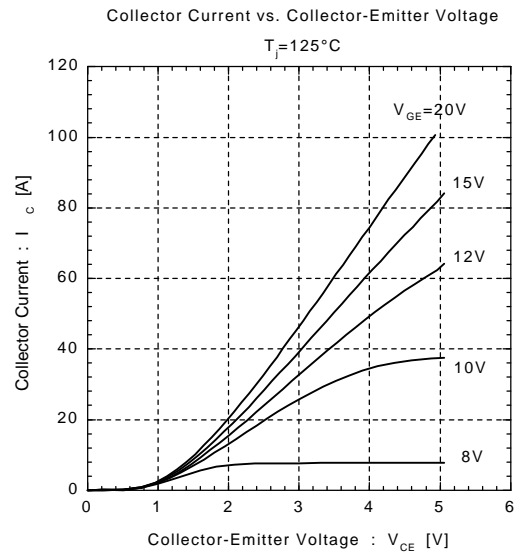
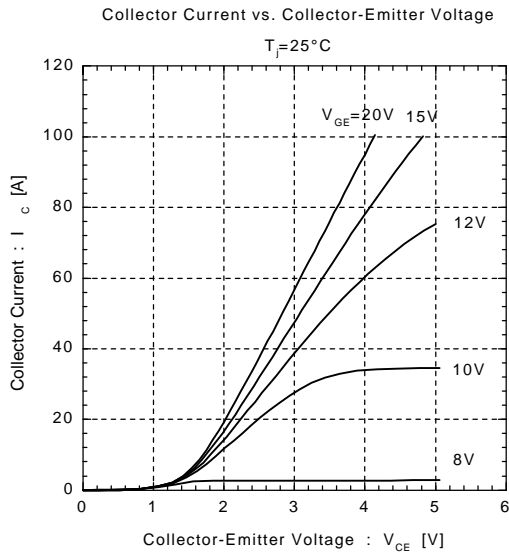

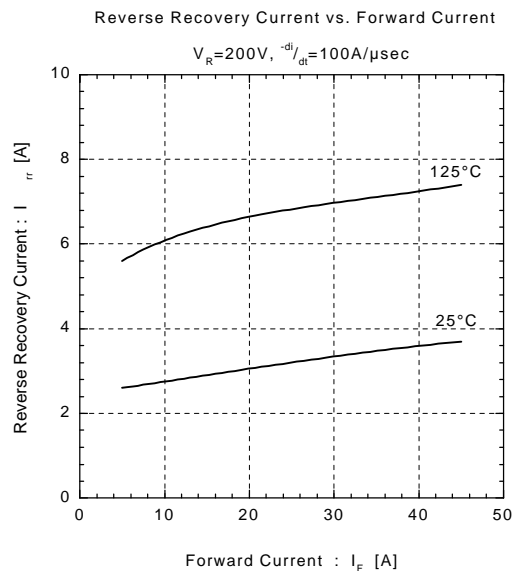
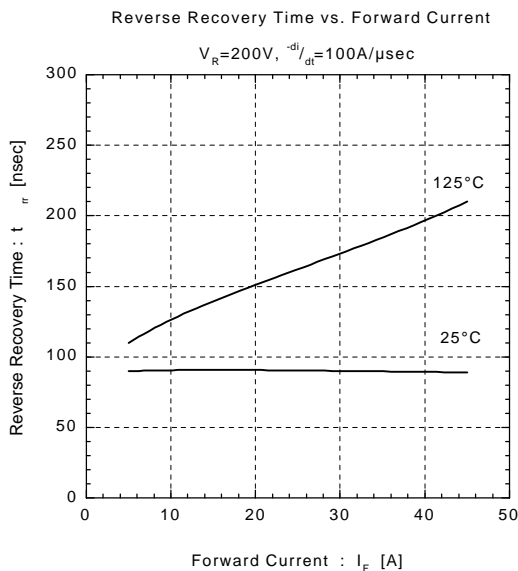
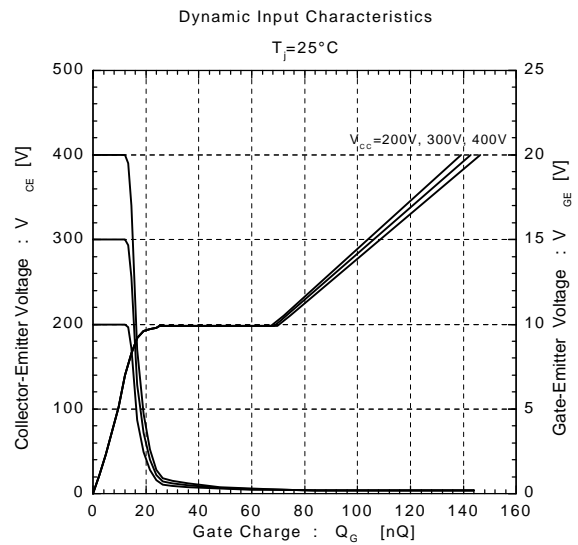
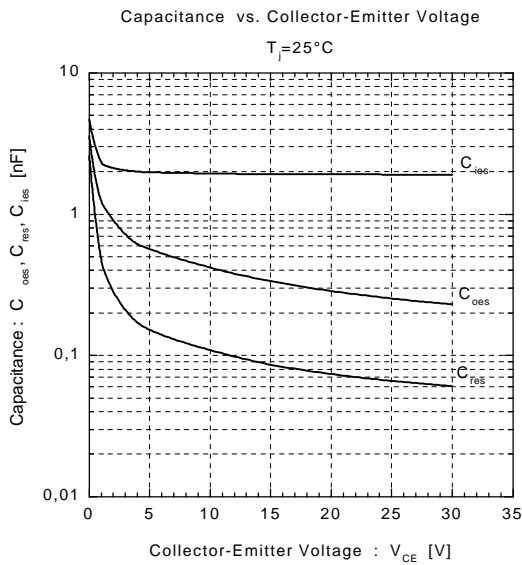
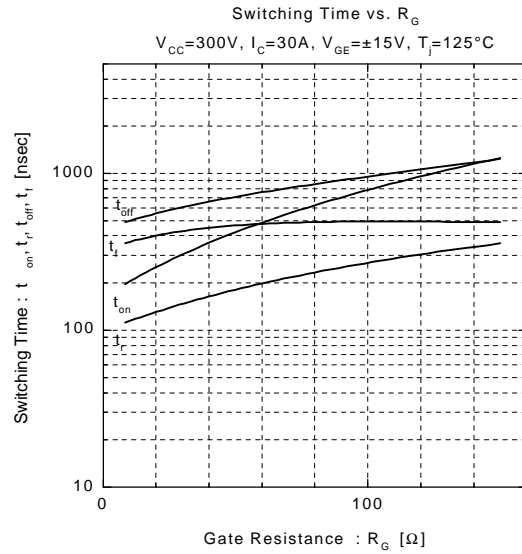
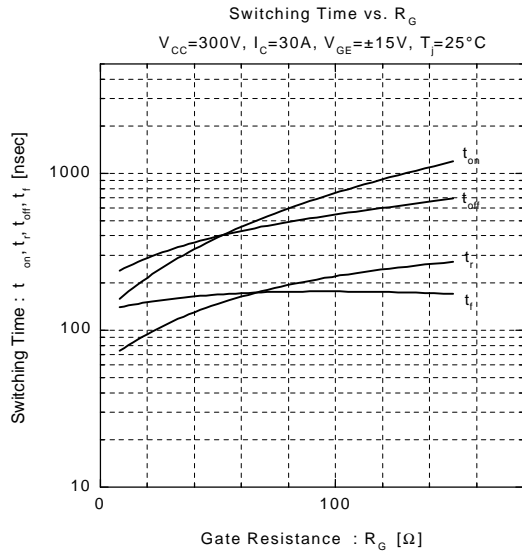

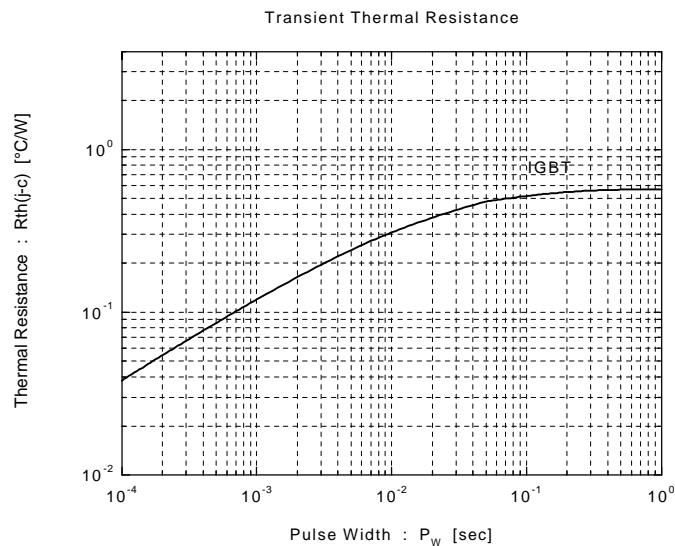
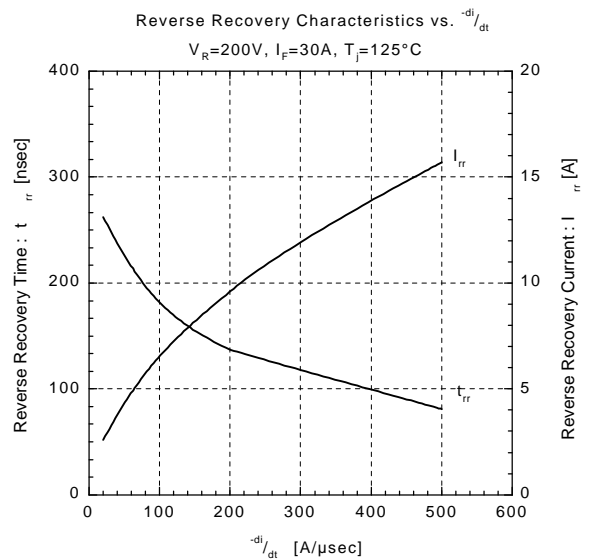
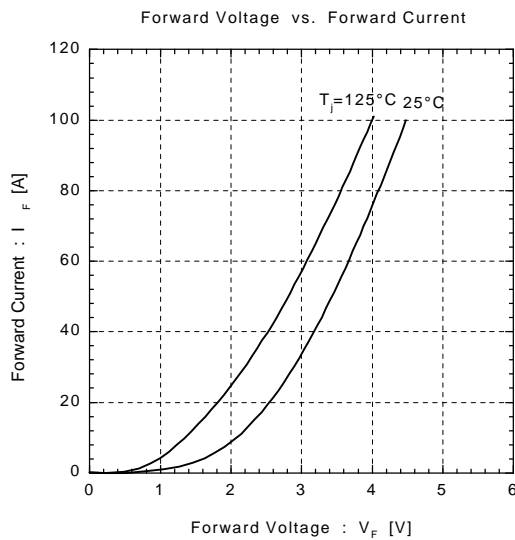
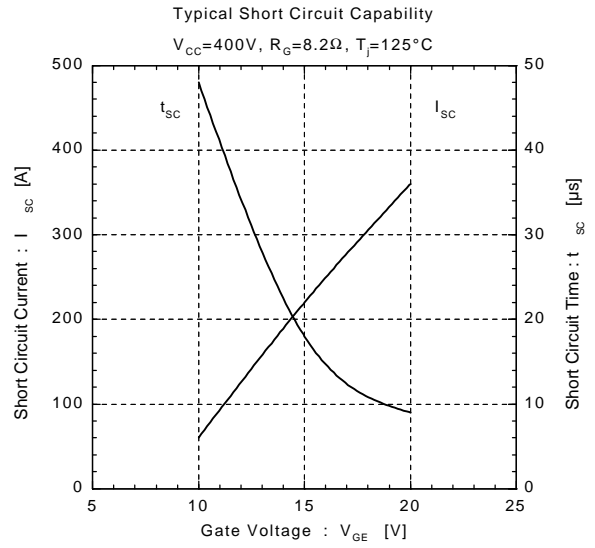
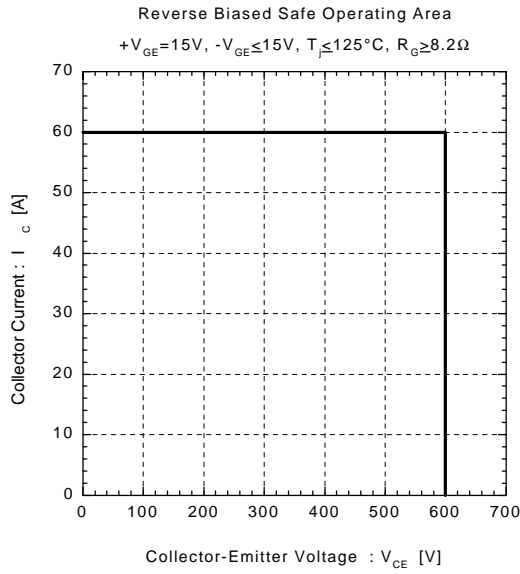

This datasheet has been download from:

[www.datasheetcatalog.com](http://www.datasheetcatalog.com)

Datasheets for electronics components.