

### IGBT MODULE (S series) 600V / 50A / PIM



#### ■ Features

- Low  $V_{CE(sat)}$
- Compact package
- P.C. board mount
- Converter diode bridge, Dynamic brake circuit

#### ■ Applications

- Inverter for motor drive
- AC and DC servo drive amplifier
- Uninterruptible power supply

#### ■ Maximum ratings and characteristics

● Absolute maximum ratings ( $T_c=25^\circ\text{C}$  unless without specified)

| Item                                                                                      | Symbol                          | Condition     | Rating                         | Unit             |                      |
|-------------------------------------------------------------------------------------------|---------------------------------|---------------|--------------------------------|------------------|----------------------|
| Inverter                                                                                  | Collector-Emitter voltage       | $V_{CES}$     | 600                            | V                |                      |
|                                                                                           | Gate-Emitter voltage            | $V_{GES}$     | $\pm 20$                       | V                |                      |
|                                                                                           | Collector current               | $I_C$         | Continuous                     | 50               | A                    |
|                                                                                           |                                 | $I_{CP}$      | 1ms                            | 100              | A                    |
|                                                                                           |                                 | $-I_C$        |                                | 50               | A                    |
| Collector power dissipation                                                               | $P_C$                           | 1 device      | 200                            | W                |                      |
| Brake                                                                                     | Collector-Emitter voltage       | $V_{CES}$     | 600                            | V                |                      |
|                                                                                           | Gate-Emitter voltage            | $V_{GES}$     | $\pm 20$                       | V                |                      |
|                                                                                           | Collector current               | $I_C$         | Continuous                     | 30               | A                    |
|                                                                                           |                                 | $I_{CP}$      | 1ms                            | 60               | A                    |
|                                                                                           | Collector power dissipation     | $P_C$         | 1 device                       | 120              | W                    |
| Converter                                                                                 | Repetitive peak reverse voltage | $V_{RRM}$     | 600                            | V                |                      |
|                                                                                           | Repetitive peak reverse voltage | $V_{RRM}$     | 800                            | V                |                      |
|                                                                                           | Average output current          | $I_O$         | 50Hz/60Hz sine wave            | 50               | A                    |
|                                                                                           | Surge current (Non-Repetitive)  | $I_{FSM}$     | $T_j=150^\circ\text{C}$ , 10ms | 350              | A                    |
|                                                                                           | $I^2t$ (Non-Repetitive)         | $I^2t$        | half sine wave                 | 613              | $\text{A}^2\text{s}$ |
| Operating junction temperature                                                            | $T_j$                           |               | +150                           | $^\circ\text{C}$ |                      |
| Storage temperature                                                                       | $T_{stg}$                       |               | -40 to +125                    | $^\circ\text{C}$ |                      |
| Isolation between terminal and copper base *2<br>voltage between thermistor and others *3 | $V_{iso}$                       | AC : 1 minute | AC 2500                        | V                |                      |
|                                                                                           |                                 |               | AC 2500                        | V                |                      |
| Mounting screw torque                                                                     |                                 |               | 3.5 *1                         | N·m              |                      |

\*1 Recommendable value : 2.5 to 3.5 N·m (M5)

\*2 All terminals should be connected together when isolation test will be done.

\*3 Terminal 8 and 9 should be connected together. Terminal 1 to 7 and 10 to 24 should be connected together and shorted to copper base.

## ● Electrical characteristics (T<sub>j</sub>=25°C unless otherwise specified)

| Item                         | Symbol                               | Condition            | Characteristics                                   |                     |      | Unit |      |   |
|------------------------------|--------------------------------------|----------------------|---------------------------------------------------|---------------------|------|------|------|---|
|                              |                                      |                      | Min.                                              | Typ.                | Max. |      |      |   |
| Inverter                     | Zero gate voltage collector current  | ICES                 | V <sub>CE</sub> =600V, V <sub>GE</sub> =0V        |                     | 1.0  | mA   |      |   |
|                              | Gate-Emitter leakage current         | IGES                 | V <sub>CE</sub> =0V, V <sub>GE</sub> =±20V        |                     | 0.2  | μA   |      |   |
|                              | Gate-Emitter threshold voltage       | V <sub>GE(th)</sub>  | V <sub>CE</sub> =20V, I <sub>c</sub> =50mA        |                     | 5.5  | 7.8  | 8.5  | V |
|                              | Collector-Emitter saturation voltage | V <sub>CE(sat)</sub> | V <sub>GE</sub> =15V, I <sub>c</sub> =50A         | chip                | 1.8  |      | V    |   |
|                              |                                      |                      |                                                   | terminal            | 1.95 | 2.4  |      |   |
|                              | Input capacitance                    | C <sub>ies</sub>     | V <sub>GE</sub> =0V, V <sub>CE</sub> =10V, f=1MHz |                     | 5000 |      | pF   |   |
|                              | Turn-on time                         | ton                  | V <sub>CC</sub> =300V                             |                     | 0.45 | 1.2  | μs   |   |
|                              |                                      | tr                   | I <sub>c</sub> =50A                               |                     | 0.25 | 0.6  |      |   |
|                              |                                      | tr(i)                | V <sub>GE</sub> =±15V                             |                     | 0.08 |      |      |   |
|                              | Turn-off                             | toff                 | R <sub>G</sub> =51Ω                               |                     | 0.40 | 1.0  |      |   |
| tf                           |                                      |                      |                                                   | 0.05                | 0.35 |      |      |   |
| Forward on voltage           | V <sub>F</sub>                       | I <sub>F</sub> =50A  | chip                                              | 1.75                |      | V    |      |   |
|                              |                                      |                      | terminal                                          | 1.9                 | 2.6  |      |      |   |
| Reverse recovery time of FRD | t <sub>rr</sub>                      | I <sub>F</sub> =50A  |                                                   |                     | 0.3  | μs   |      |   |
| Brake                        | Zero gate voltage collector current  | ICES                 | V <sub>CE(s)</sub> =600V, V <sub>GE</sub> =0V     |                     | 1.0  | mA   |      |   |
|                              | Gate-Emitter leakage current         | IGES                 | V <sub>CE</sub> =0V, V <sub>GE</sub> =±20V        |                     | 0.2  | μA   |      |   |
|                              | Collector-Emitter saturation voltage | V <sub>CE(sat)</sub> | I <sub>c</sub> =30A, V <sub>GE</sub> =15V         | chip                | 1.8  |      | V    |   |
|                              |                                      |                      |                                                   | terminal            | 1.95 | 2.4  |      |   |
|                              | Turn-on time                         | ton                  | V <sub>CC</sub> =300V                             |                     | 0.45 | 1.2  | μs   |   |
|                              |                                      | tr                   | I <sub>c</sub> =30A                               |                     | 0.25 | 0.6  |      |   |
|                              | Turn-off time                        | toff                 | V <sub>GE</sub> =±15V                             |                     | 0.40 | 1.0  |      |   |
|                              |                                      | tf                   | R <sub>G</sub> =82Ω                               |                     | 0.05 | 0.35 |      |   |
|                              | Reverse current                      | I <sub>RRM</sub>     | V <sub>R</sub> =600V                              |                     |      | 1.0  | mA   |   |
|                              | Converter                            | Forward on voltage   | V <sub>FM</sub>                                   | I <sub>F</sub> =50A | chip | 1.1  |      | V |
| terminal                     |                                      |                      |                                                   |                     | 1.2  | 1.5  |      |   |
| Reverse current              | I <sub>RRM</sub>                     | V <sub>R</sub> =800V |                                                   |                     | 1.0  | mA   |      |   |
| Thermistor                   | Resistance                           | R                    | T=25°C                                            |                     | 5000 |      | Ω    |   |
|                              |                                      |                      | T=100°C                                           |                     | 465  | 495  | 520  |   |
|                              | B value                              | B                    | T=25/50°C                                         |                     | 3305 | 3375 | 3450 | K |

## ● Thermal resistance Characteristics

| Item                            | Symbol               | Condition             | Characteristics |      |      | Unit |
|---------------------------------|----------------------|-----------------------|-----------------|------|------|------|
|                                 |                      |                       | Min.            | Typ. | Max. |      |
| Thermal resistance ( 1 device ) | R <sub>th(j-c)</sub> | Inverter IGBT         |                 |      | 0.63 | °C/W |
|                                 |                      | Inverter FWD          |                 |      | 1.33 |      |
|                                 |                      | Brake IGBT            |                 |      | 1.04 |      |
|                                 |                      | Converter Diode       |                 |      | 0.90 |      |
| Contact thermal resistance *    | R <sub>th(c-f)</sub> | With thermal compound |                 | 0.05 |      |      |

\* This is the value which is defined mounting on the additional cooling fin with thermal compound

## ■ Equivalent Circuit Schematic

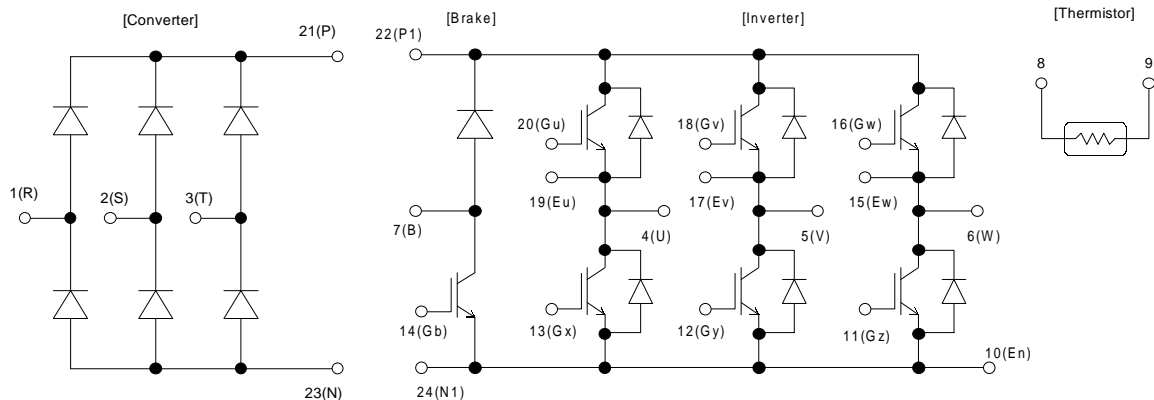

## Characteristics (Representative)

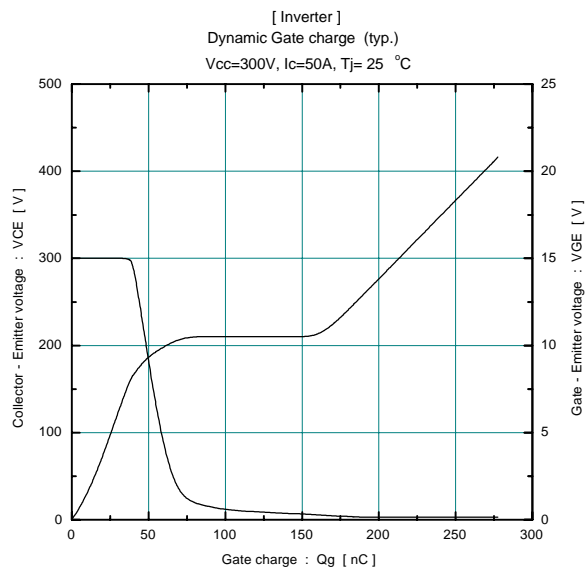
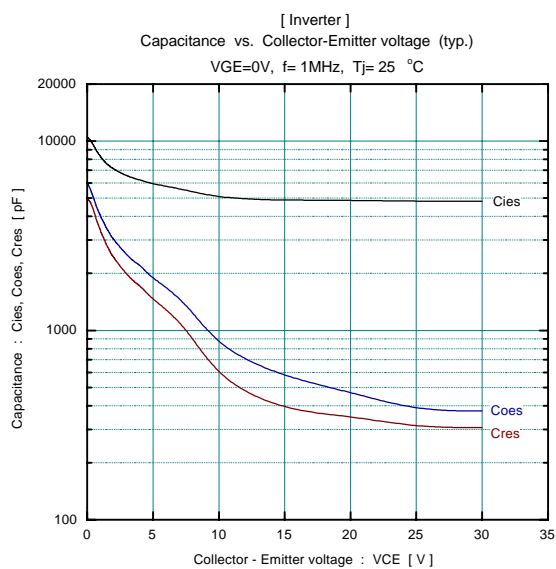
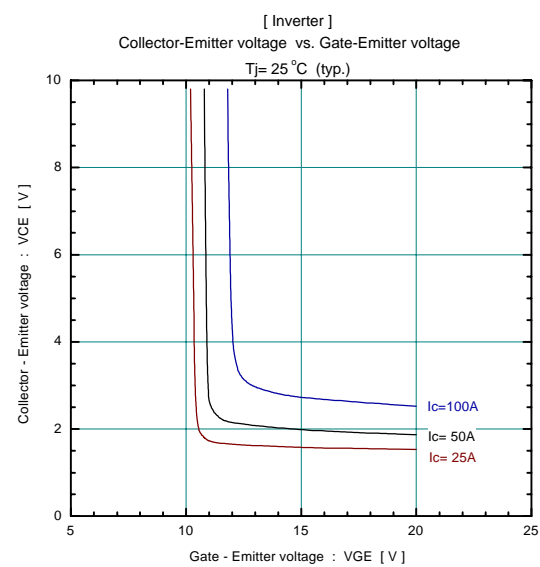
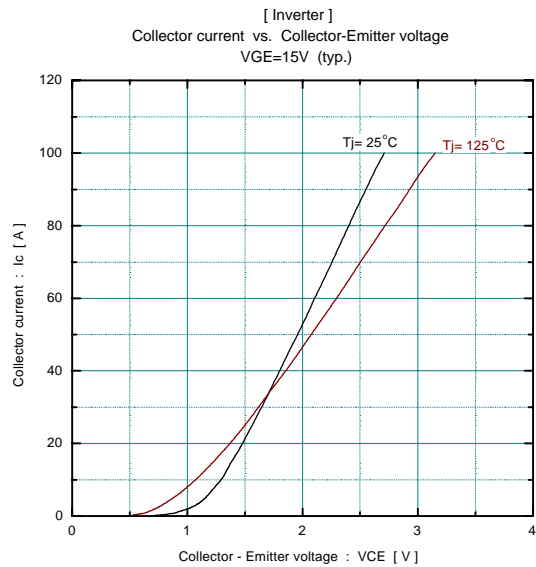
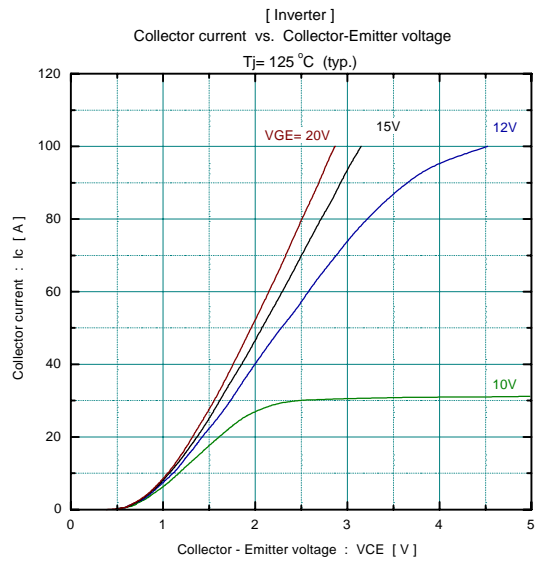
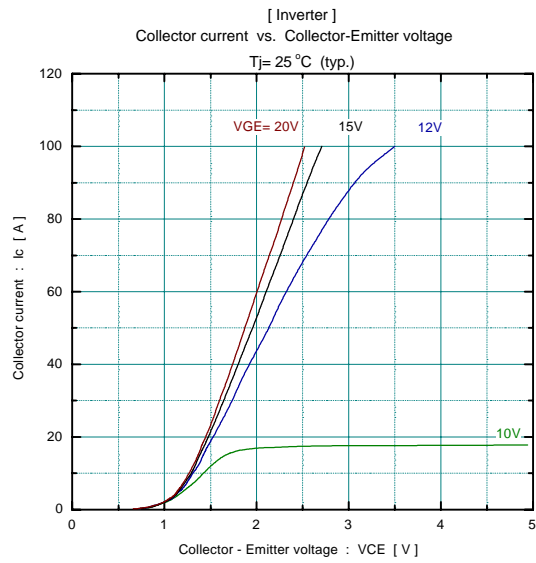

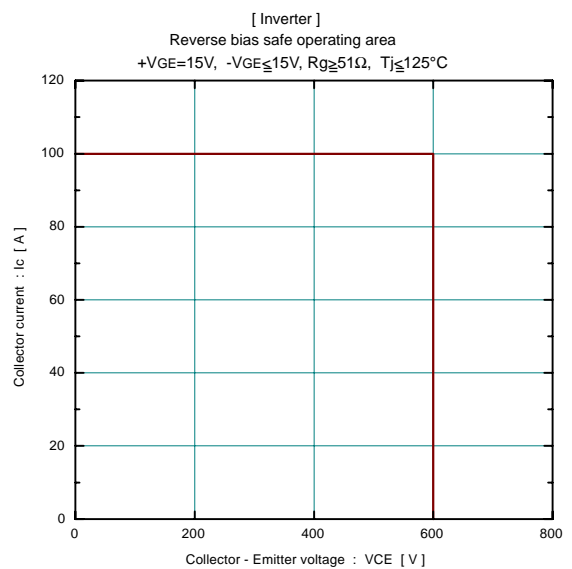
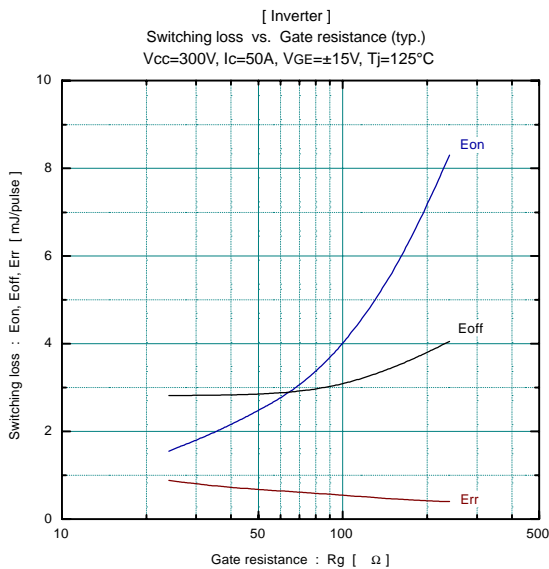
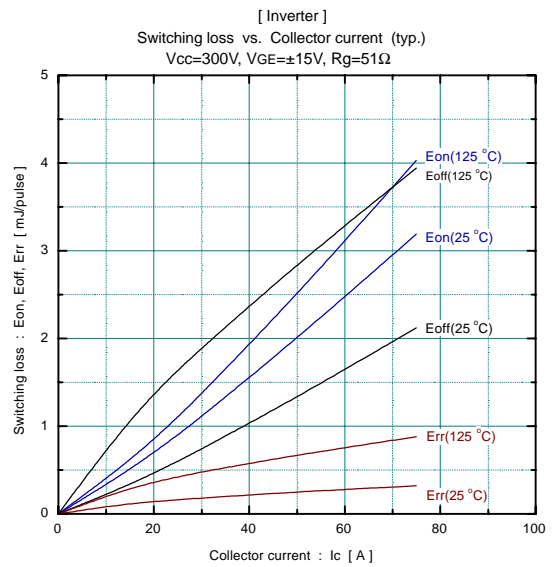
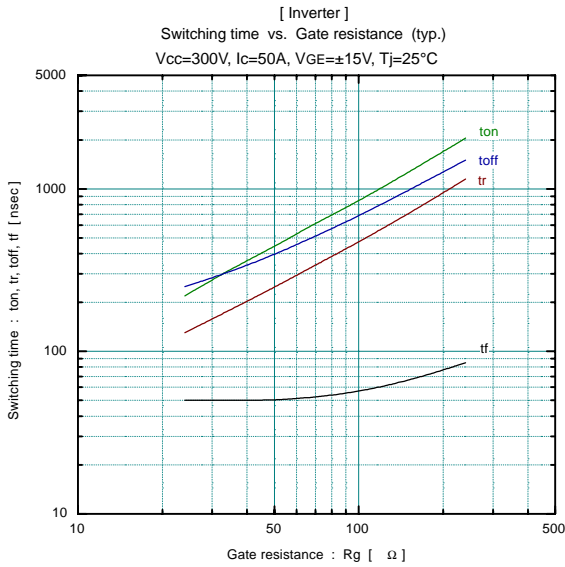
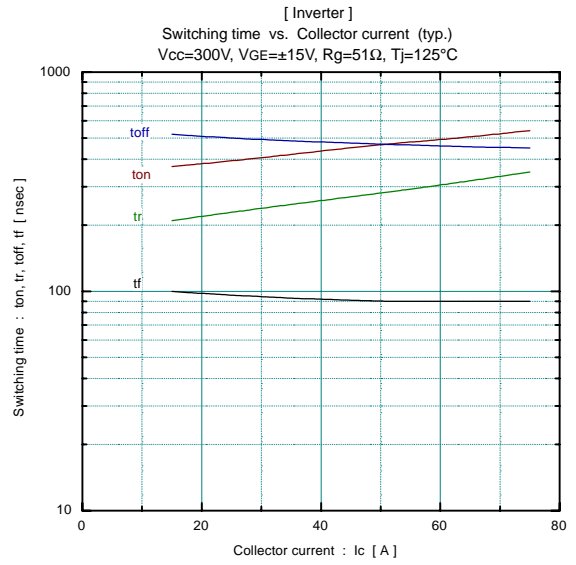
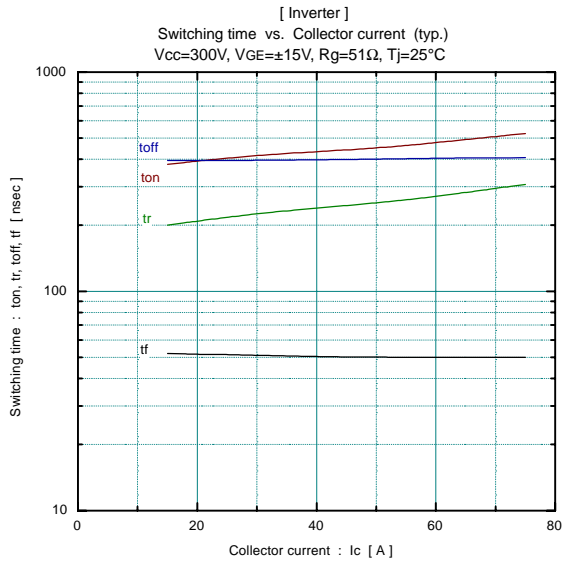

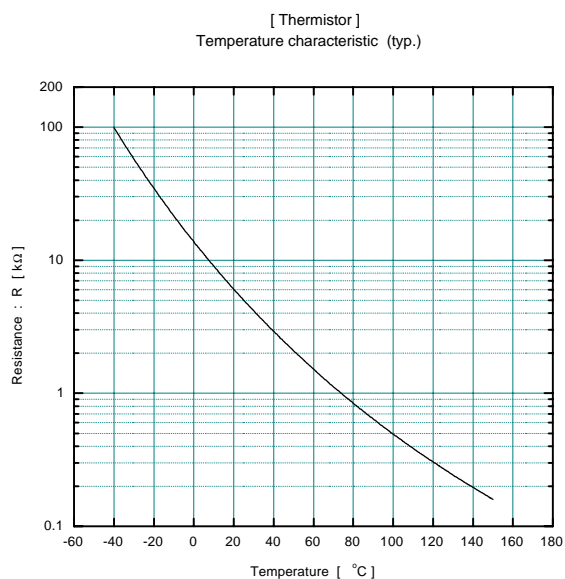
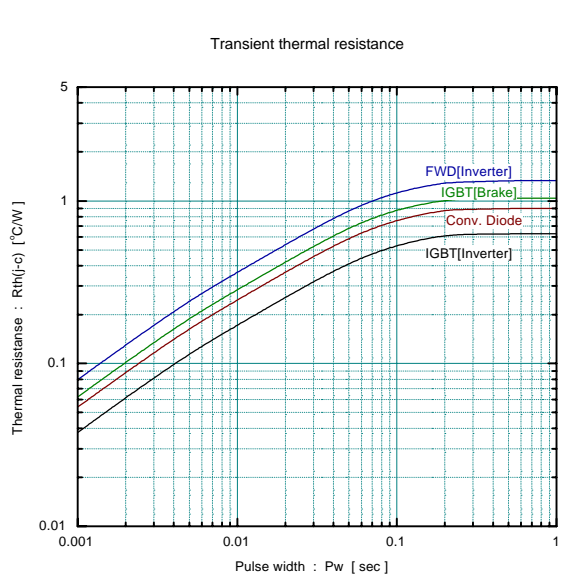
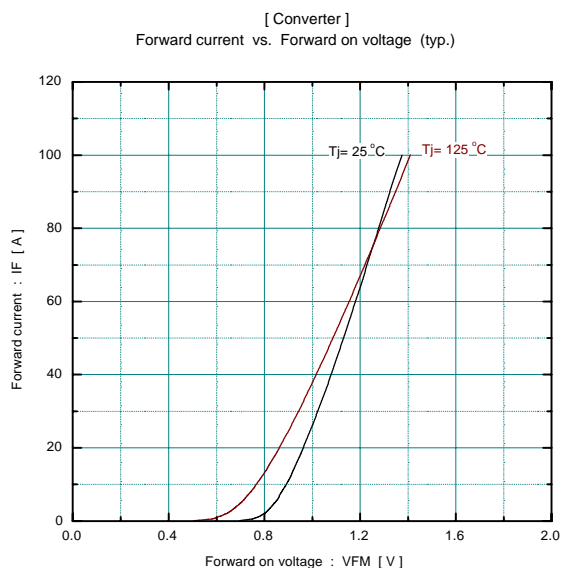
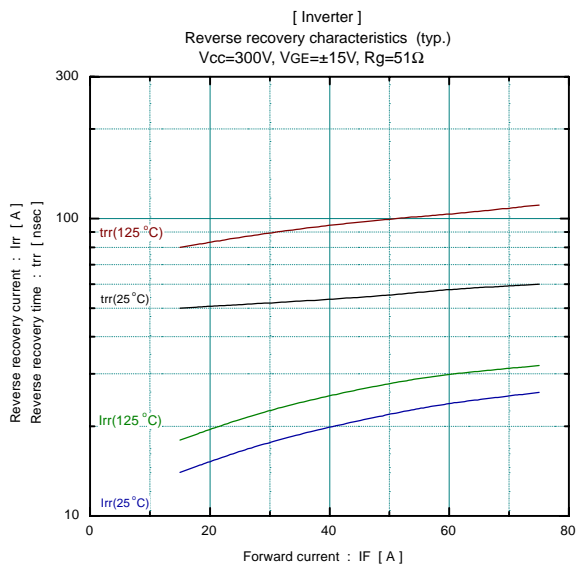
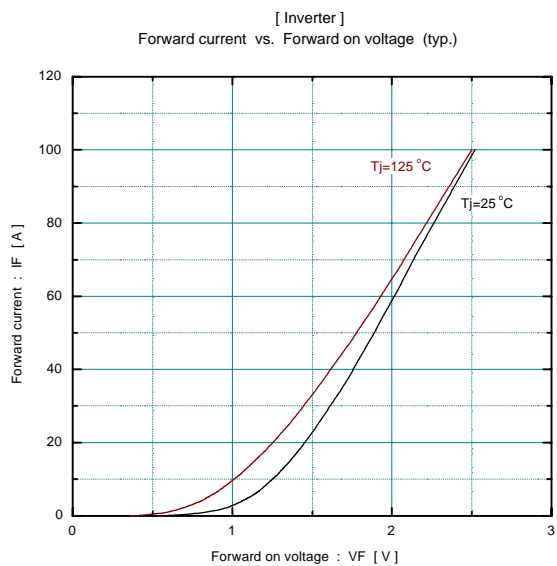

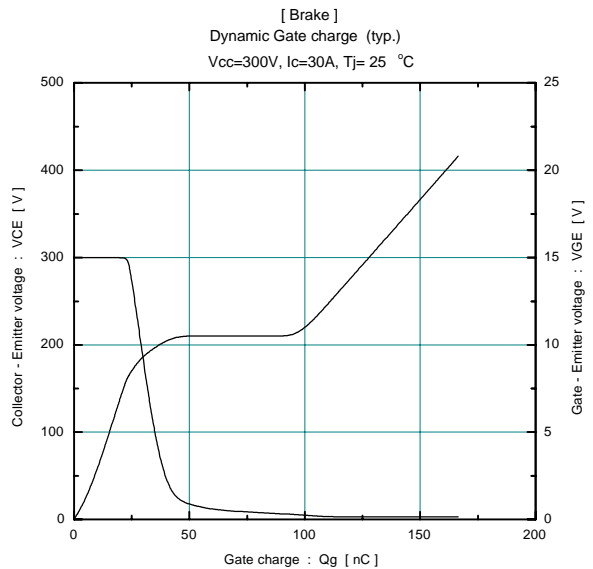
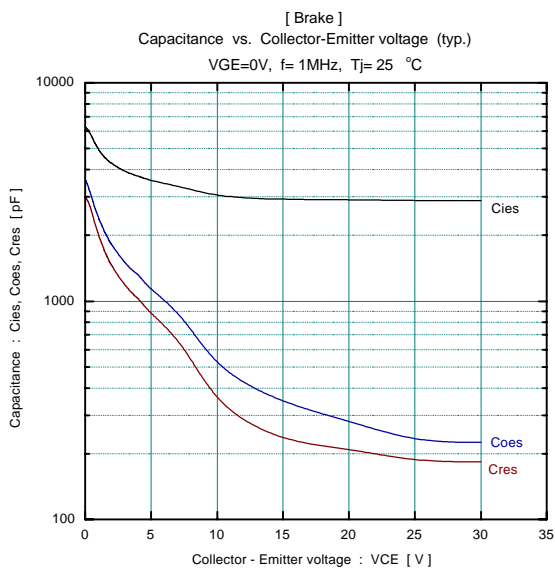
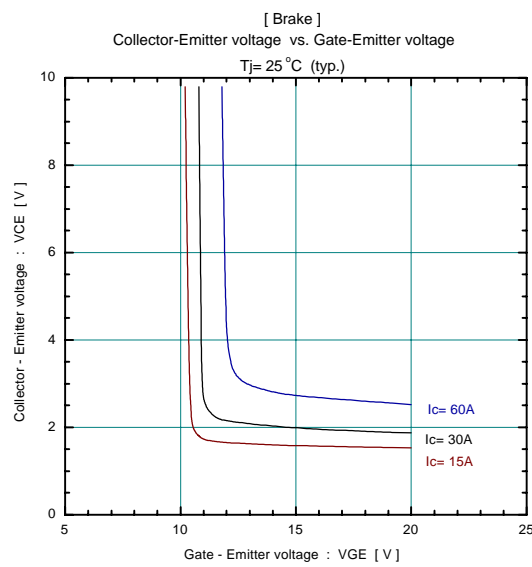
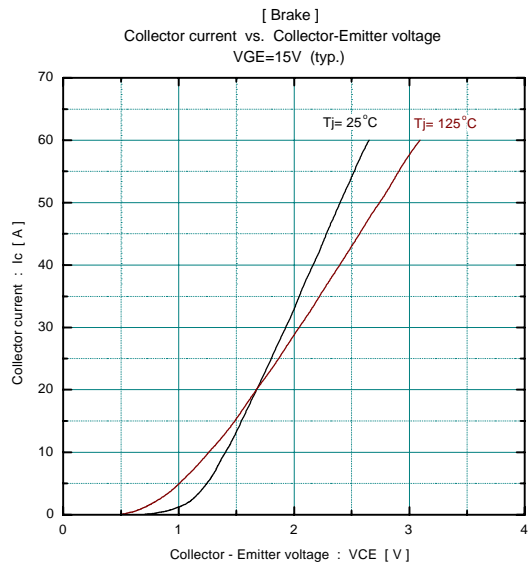
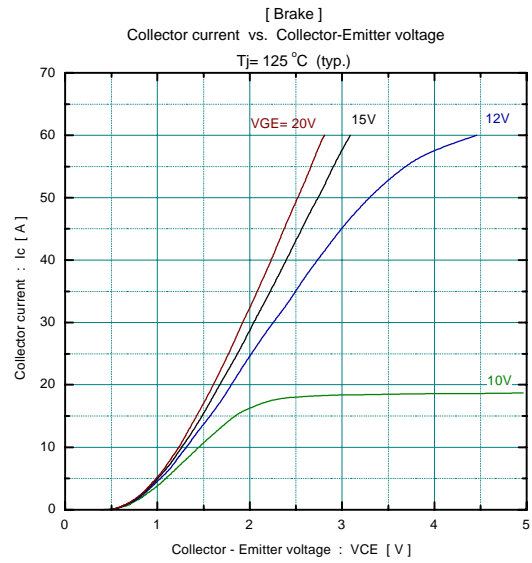
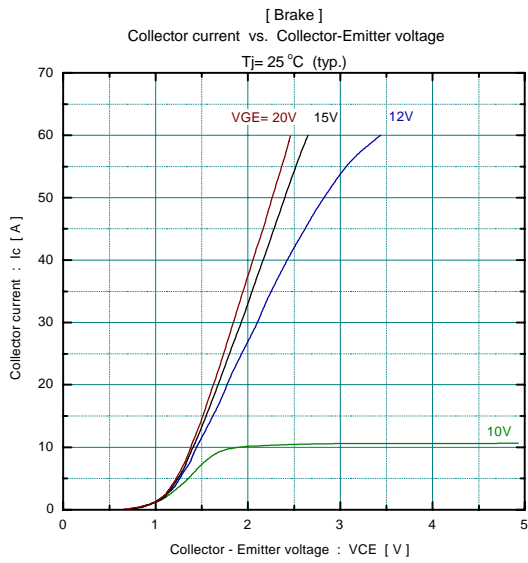

■ Outline Drawings, mm

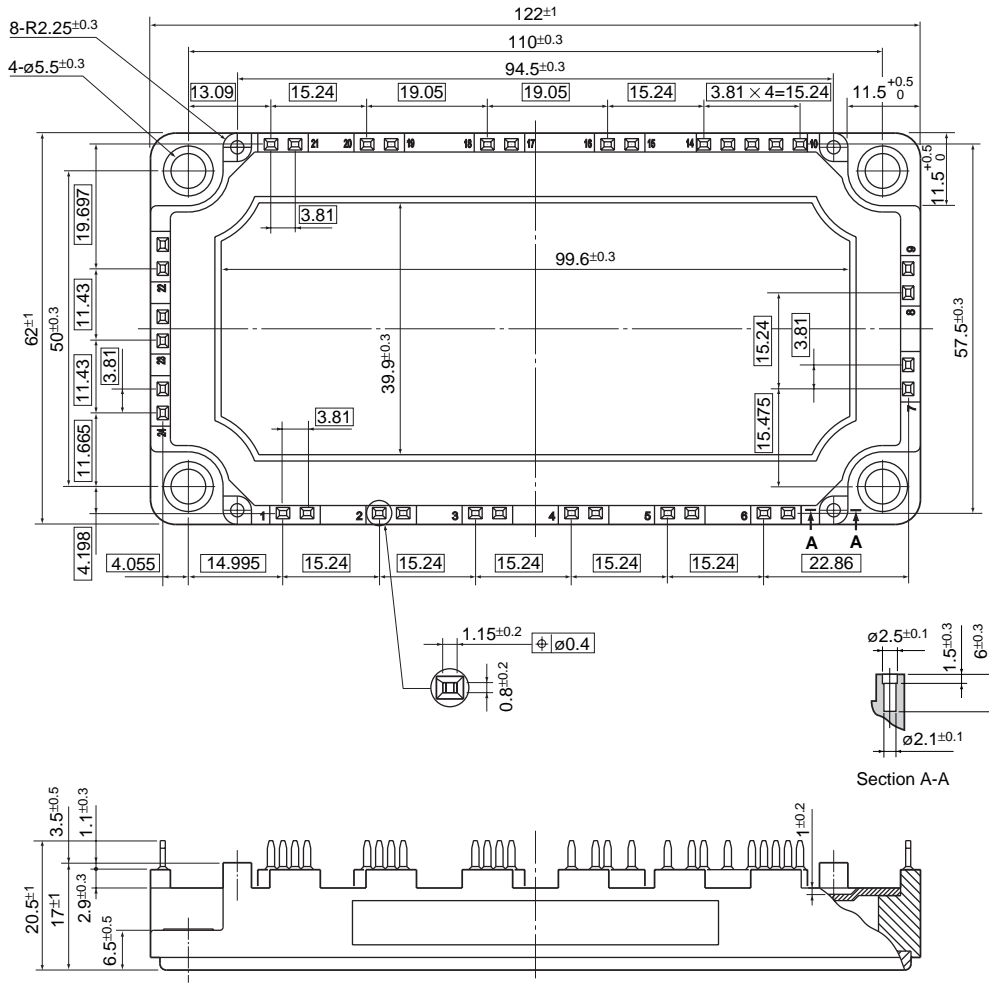

□ Shows theory dimensions