

### IGBT MODULE (U series) 600V / 30A / PIM



#### ■ Features

- Low  $V_{CE(sat)}$
- Compact Package
- P.C. Board Mount Module
- Converter Diode Bridge Dynamic Brake Circuit

#### ■ Applications

- Inverter for Motoe Drive
- AC and DC Servo Drive Amplifier
- Uninterruptible Power Supply

#### ■ Maximum ratings and characteristics

● Absolute maximum ratings ( $T_c=25^\circ\text{C}$  unless ptherwise specified)

Item	Symbol	Condition	Rating	Unit	
Inverter	Collector-Emitter voltage	$V_{CES}$	600	V	
	Gate-Emitter voltage	$V_{GES}$	$\pm 20$	V	
	Collector current	$I_C$	Continuous	30	A
		$I_{CP}$	1ms	60	
		$-I_C$		30	
		$-I_C$ pulse	1ms	60	
Collector power dissipation	$P_C$	1 device	133	W	
Brake	Collector-Emitter voltage	$V_{CES}$	600	V	
	Gate-Emitter voltage	$V_{GES}$	$\pm 20$	V	
	Collector current	$I_C$	Continuous	20	A
		$I_{CP}$	1ms	40	A
	Collector power dissipation	$P_C$	1 device	104	W
	Repetitive peak reverse voltage	$V_{RRM}$		600	V
Converter	Repetitive peak reverse voltage	$V_{RRM}$	800	V	
	Average output current	$I_o$	50Hz/60Hz sine wave	30	A
	Surge current (Non-Repetitive)	$I_{FSM}$	$T_j=150^\circ\text{C}$ , 10ms	210	A
	$I^2t$ (Non-Repetitive)	$I^2t$	half sine wave	221	$\text{A}^2\text{s}$
Operating junction temperature	$T_j$		+150	$^\circ\text{C}$	
Storage temperature	$T_{stg}$		-40 to +125	$^\circ\text{C}$	
Isolation voltage	between terminal and copper base *2 between thermistor and others *3	$V_{iso}$	AC : 1 minute	AC 2500	V
				AC 2500	
Mounting screw torque			3.5 *1	N·m	

\*1 Recommendable value : 2.5 to 3.5 N·m (M5)

\*2 All terminals should be connected together when isolation test will be done.

\*3 Two thermistor terminals should be connected together, each other terminals should be connected together and shorted to base plate when isolation test will be done.

## ● Electrical characteristics (T<sub>j</sub>=25°C unless otherwise specified)

Item	Symbol	Condition	Characteristics			Unit			
			Min.	Typ.	Max.				
Inverter	Zero gate voltage collector current	ICES	V <sub>CE</sub> =600V, V <sub>GE</sub> =0V			1.0	mA		
	Gate-Emitter leakage current	IGES	V <sub>CE</sub> =0V, V <sub>GE</sub> =±20V			200	nA		
	Gate-Emitter threshold voltage	V <sub>GE(th)</sub>	V <sub>CE</sub> =20V, I <sub>C</sub> =30mA			6.2	6.7	7.7	V
	Collector-Emitter saturation voltage	V <sub>CE(sat)</sub> (terminal)	V <sub>GE</sub> =15V I <sub>C</sub> =30A	T <sub>J</sub> =25°C		2.10	2.40	V	
				T <sub>J</sub> =125°C		2.40			
		V <sub>CE(sat)</sub> (chip)		T <sub>J</sub> =25°C		1.85			
				T <sub>J</sub> =125°C		2.15			
	Input capacitance	C <sub>ies</sub>	V <sub>GE</sub> =0V, V <sub>CE</sub> =10V, f=1MHz			1.7		nF	
	Turn-on time	t <sub>on</sub>	V <sub>CC</sub> =300V			0.36	1.20	μs	
		t <sub>r</sub>	I <sub>C</sub> =30A			0.20	0.60		
		t <sub>r(i)</sub>	V <sub>GE</sub> =±15V			0.05			
	Turn-off time	t <sub>off</sub>	R <sub>G</sub> =120Ω			0.45	1.20	μs	
		t <sub>f</sub>				0.04	0.45		
Forward on voltage	V <sub>F</sub> (terminal)	V <sub>GE</sub> =0V I <sub>F</sub> =30A	T <sub>J</sub> =25°C		2.10	2.65	V		
			T <sub>J</sub> =125°C		2.00				
	V <sub>F</sub> (chip)		T <sub>J</sub> =25°C		1.85				
			T <sub>J</sub> =125°C		1.75				
Reverse recovery time	t <sub>rr</sub>	I <sub>F</sub> =30A				0.35	μs		
Brake	Zero gate voltage collector current	ICES	V <sub>CE</sub> =600V, V <sub>GE</sub> =0V			1.0	mA		
	Gate-Emitter leakage current	IGES	V <sub>CE</sub> =0V, V <sub>GE</sub> =±20V			200	nA		
	Collector-Emitter saturation voltage	V <sub>CE(sat)</sub> (terminal)	I <sub>C</sub> =20A V <sub>GE</sub> =15V	T <sub>J</sub> =25°C		1.85	2.15	V	
				T <sub>J</sub> =125°C		2.15			
		V <sub>CE(sat)</sub> (chip)		T <sub>J</sub> =25°C		1.70			
				T <sub>J</sub> =125°C		2.00			
	Turn-on time	t <sub>on</sub>	V <sub>CC</sub> =300V			0.45	1.20	μs	
		t <sub>r</sub>	I <sub>C</sub> =20A			0.15	0.60		
	Turn-off time	t <sub>off</sub>	V <sub>GE</sub> =±15V			0.37	1.20	μs	
		t <sub>f</sub>	R <sub>G</sub> =150Ω			0.04	0.45		
	Reverse current	I <sub>RRM</sub>	V <sub>R</sub> =600V				1.0	mA	
	Converter	Forward on voltage	V <sub>FM</sub>	I <sub>F</sub> =30A	terminal	1.20	1.50	V	
				V <sub>GE</sub> =0V	chip	1.10			
Reverse current	I <sub>RRM</sub>	V <sub>R</sub> =800V				1.0	mA		
Thermistor	Resistance	R	T=25°C			5000	Ω		
			T=100°C			465		495	520
B value	B	T=25/50°C			3305	3375	3450	K	

## ● Thermal resistance Characteristics

Item	Symbol	Condition	Characteristics			Unit
			Min.	Typ.	Max.	
Thermal resistance ( 1 device )	R <sub>th(j-c)</sub>	Inverter IGBT			0.94	°C/W
		Inverter FWD			1.60	
		Brake IGBT			1.20	
		Converter Diode			1.20	
Contact thermal resistance *	R <sub>th(c-f)</sub>	With thermal compound			0.05	

\* This is the value which is defined mounting on the additional cooling fin with thermal compound

## ■ Equivalent Circuit Schematic

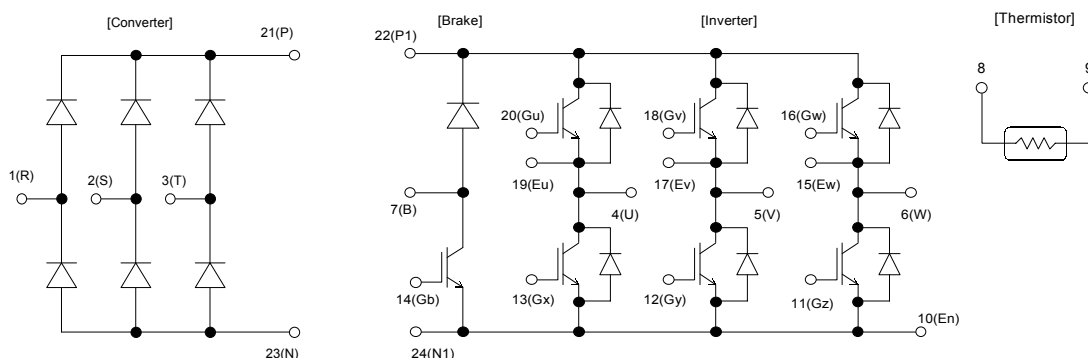

■ Characteristics (Representative)

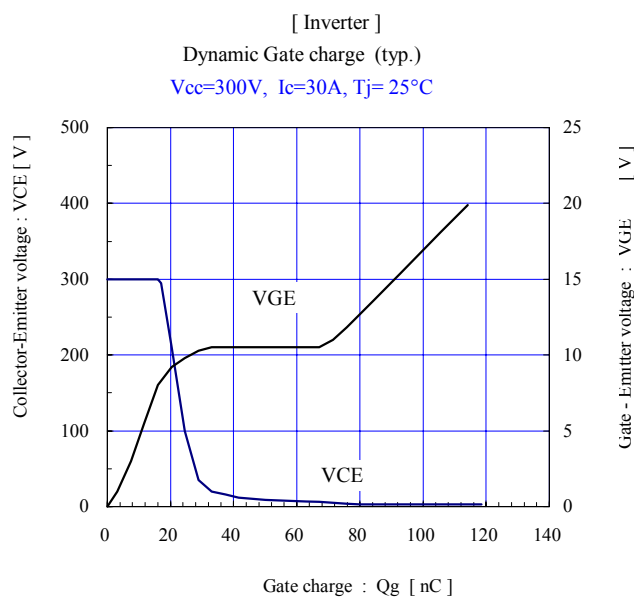
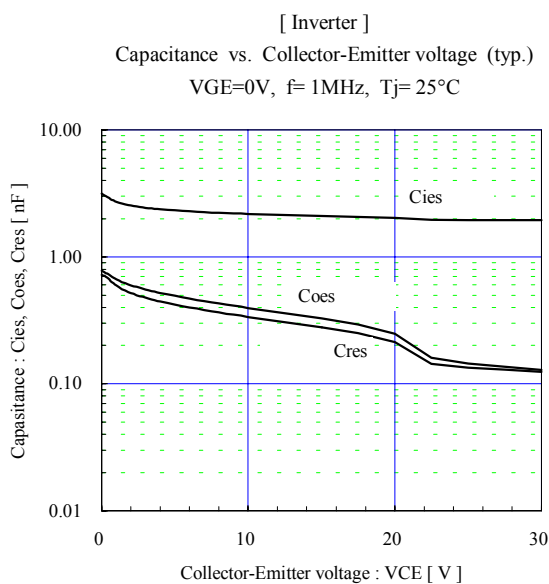
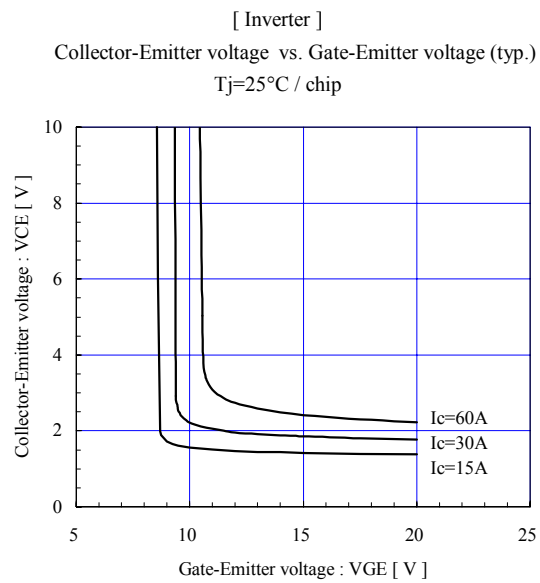
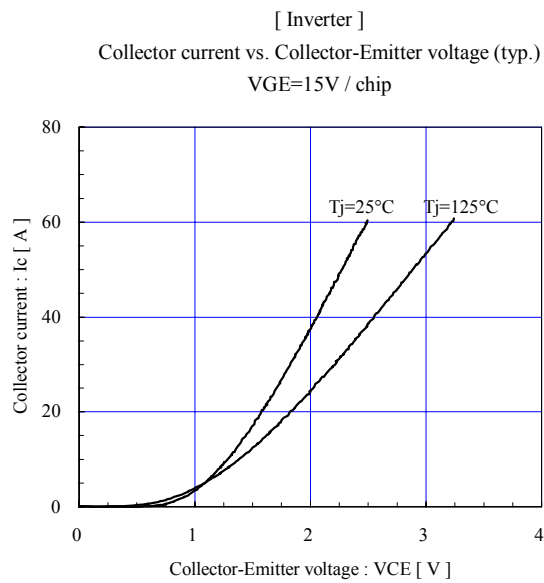
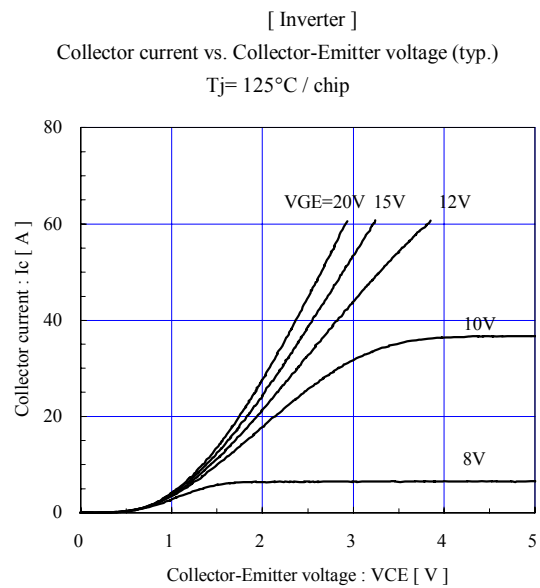
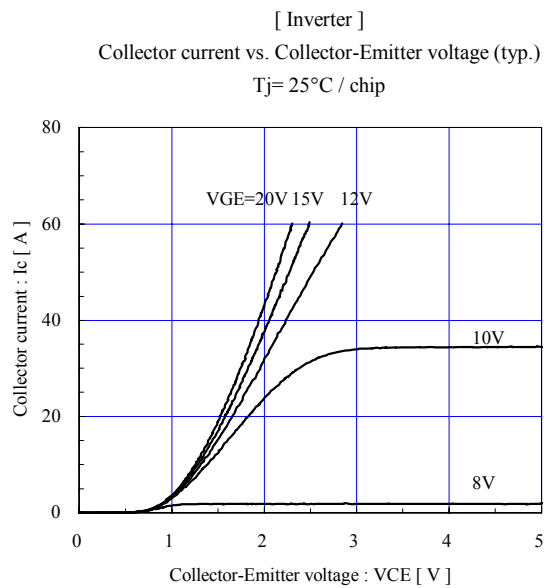

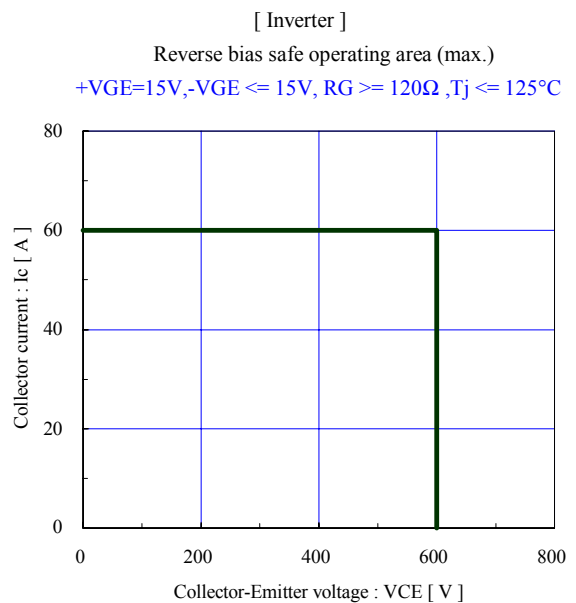
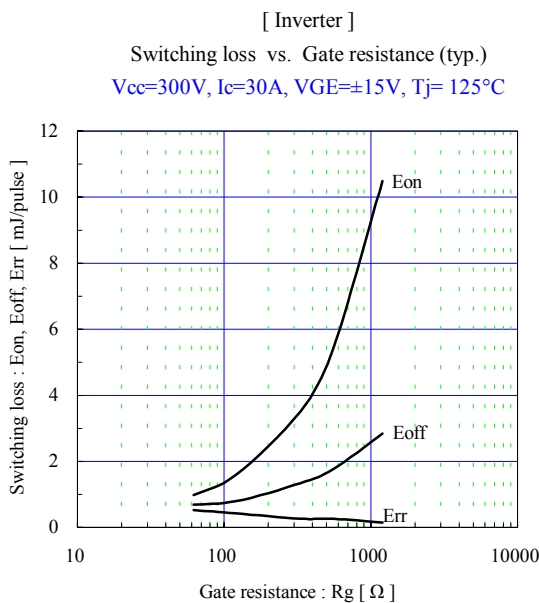
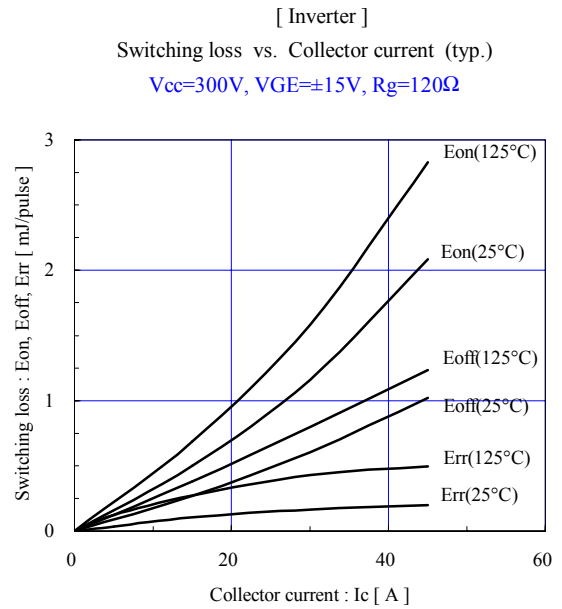
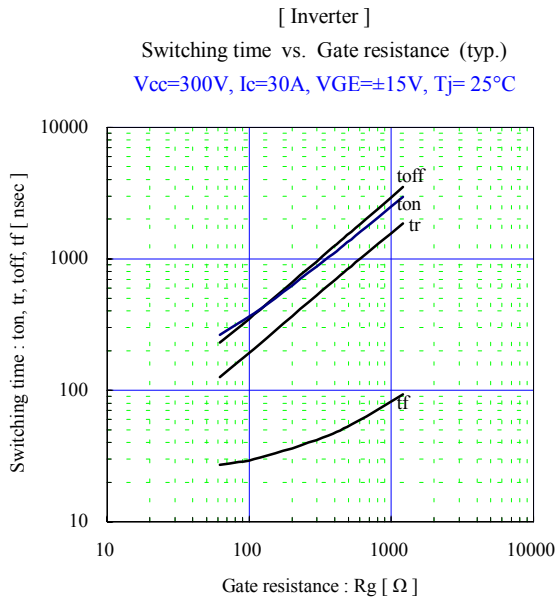
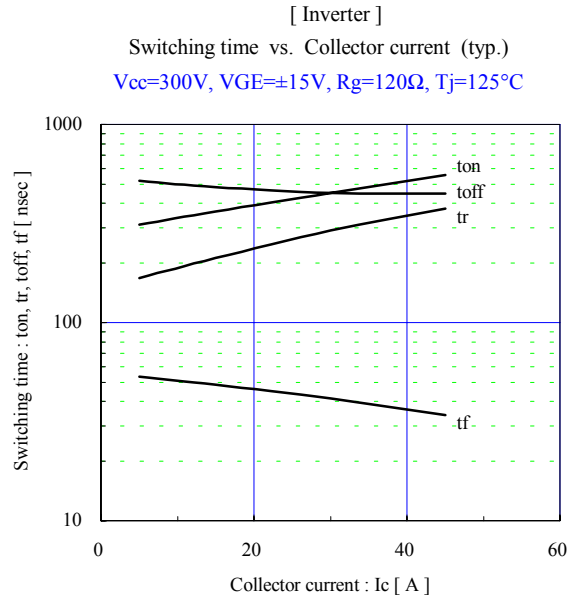
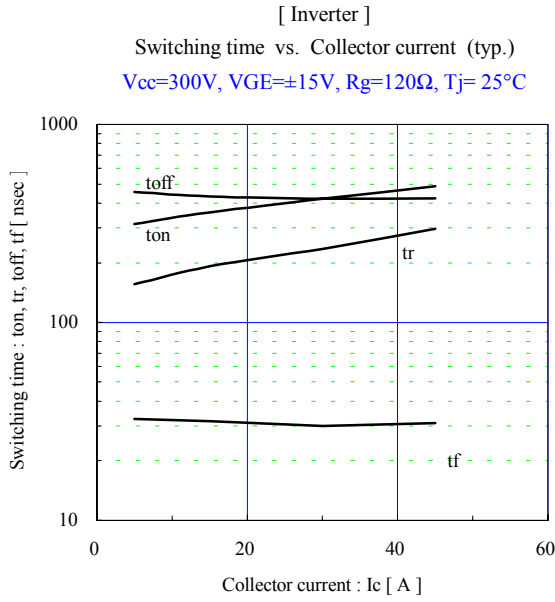

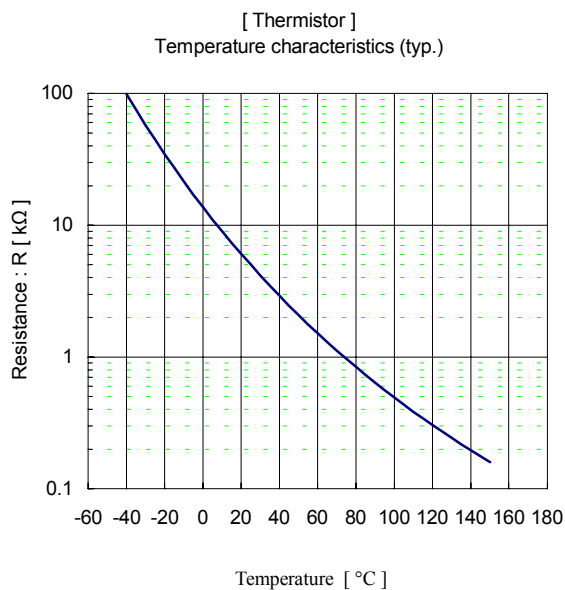
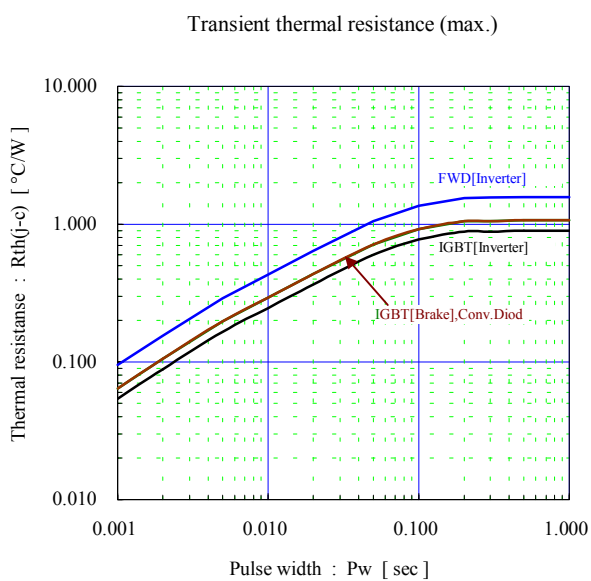
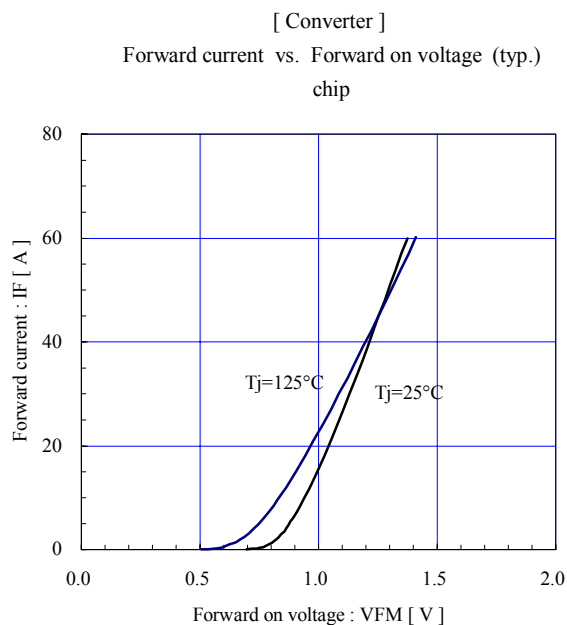
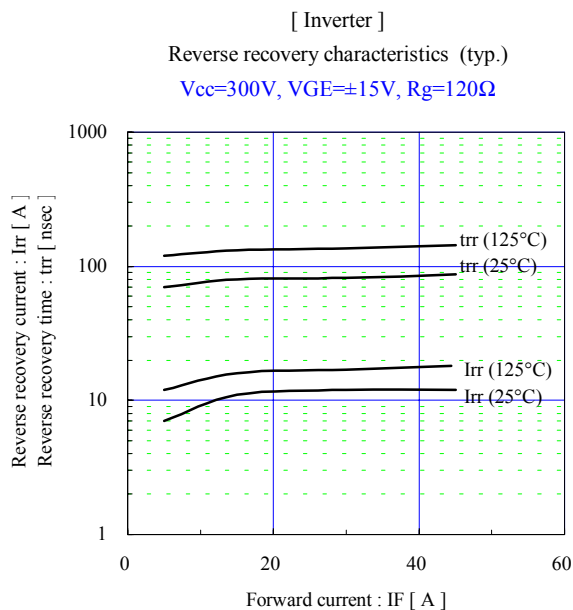
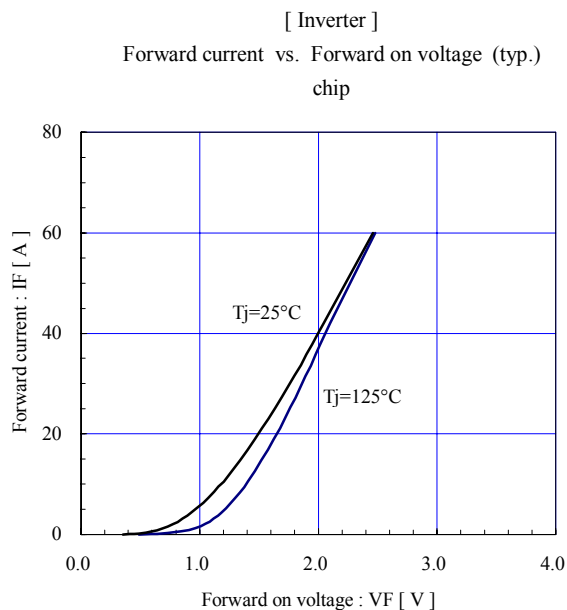

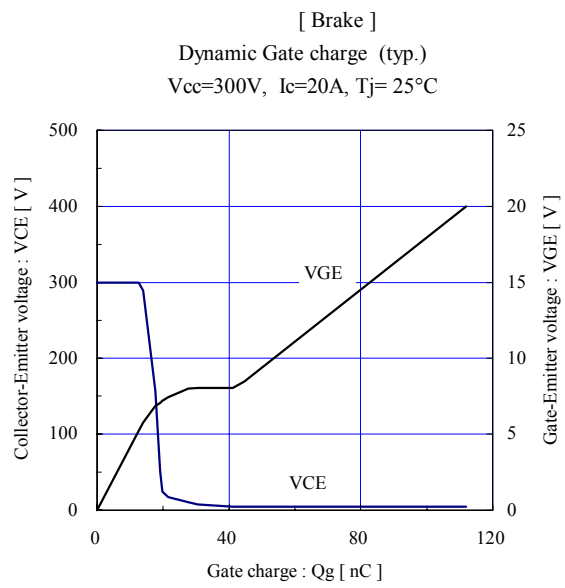
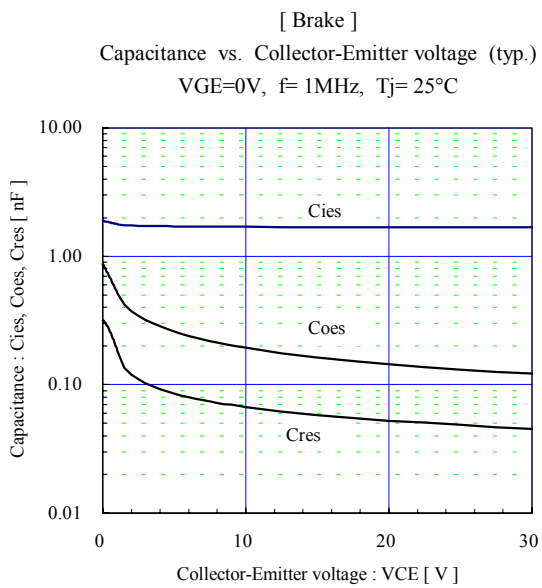
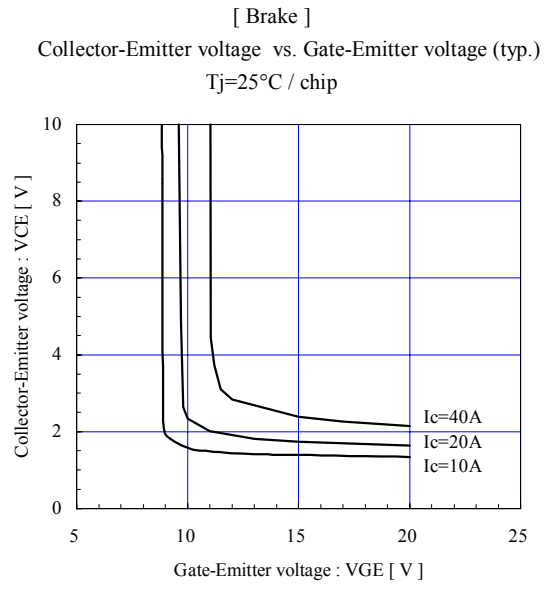
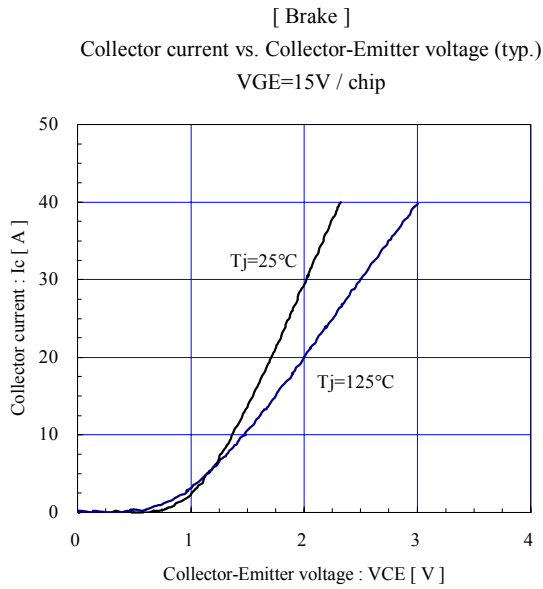
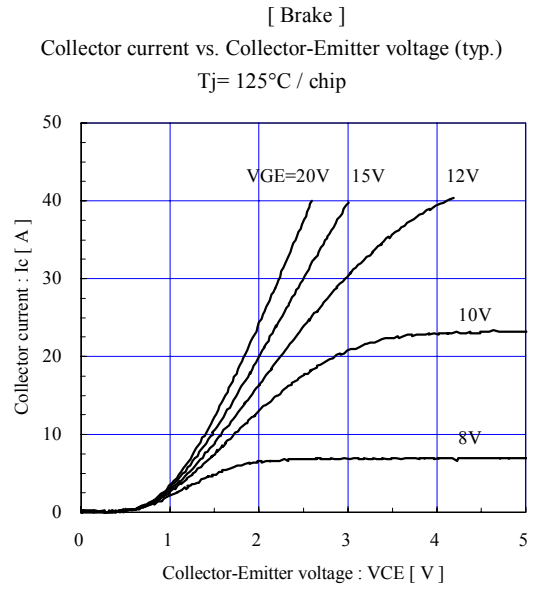
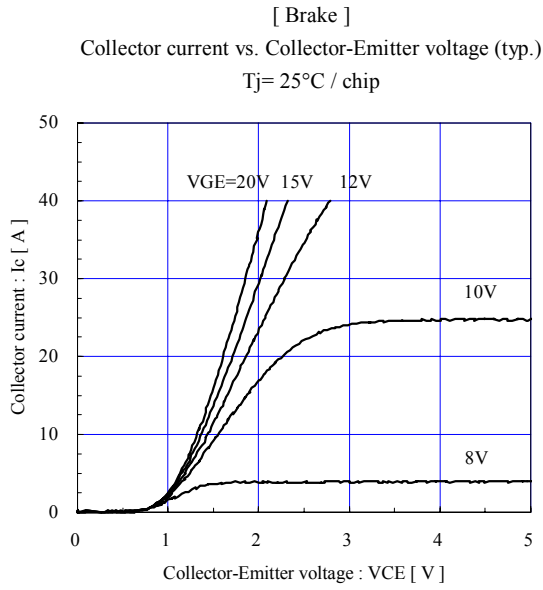

■ Outline Drawings, mm

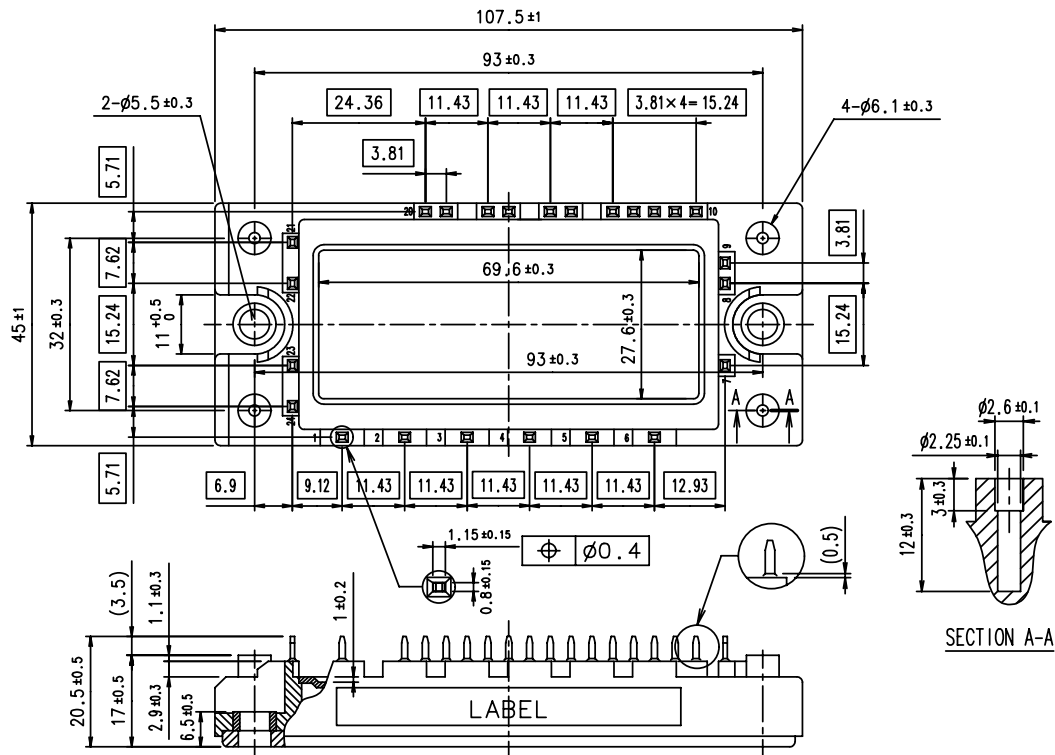

□ shows theoretical dimension.  
 ( ) shows reference dimension.