

6MBP75RTB060

IPM-R3 series

600V / 75A 6 in one-package

Features

- Temperature protection provided by directly detecting the junction temperature of the IGBTs
- Low power loss and soft switching
- High performance and high reliability IGBT with overheating protection
- Higher reliability because of a big decrease in number of parts in built-in control circuit

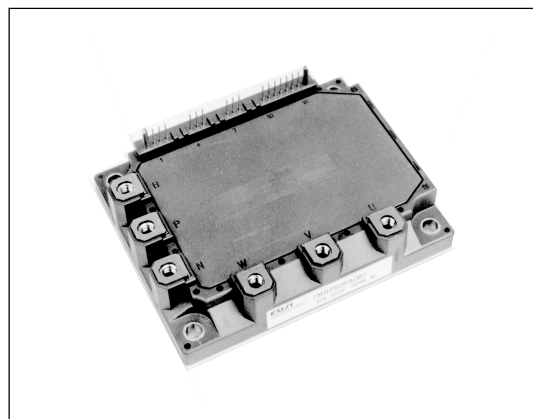

Maximum ratings and characteristics

● Absolute maximum ratings(at Tc=25°C unless otherwise specified)

Item	Symbol	Rating		Unit		
		Min.	Max.			
DC bus voltage	VDC	0	450	V		
DC bus voltage (surge)	VDC(surge)	0	500	V		
DC bus voltage (short operating)	VSC	200	400	V		
Collector-Emitter voltage	VCES *1	0	600	V		
INV Collector current	DC	Ic	-	75	A	
			1ms	IcP	-	150
	Duty=74.9%	-Ic	*2	-	75	A
Collector power dissipation	One transistor	PC	*3	-	198	W
Junction temperature	Tj	-	150	°C		
Input voltage of power supply for Pre-Driver	VCC *4	-0.5	20	V		
Input signal voltage	Vin *5	-0.5	Vcc+0.5	V		
Input signal current	Iin	-	3	mA		
Alarm signal voltage	VALM *6	-0.5	Vcc	V		
Alarm signal current	IALM *7	-	20	mA		
Storage temperature	Tsg	-40	125	°C		
Operating case temperature	Topr	-20	100	°C		
Isolating voltage (Case-Terminal)	Viso *8	-	AC2.5	kV		
Screw torque	Mounting (M5)	-	3.5 *9	N·m		
	Terminal (M5)	-	3.5 *9	N·m		

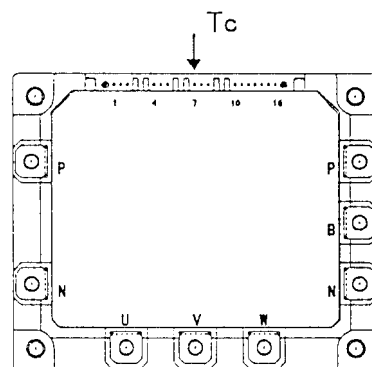

Fig.1 Measurement of case temperature

*1 : Vces shall be applied to the input voltage between terminal P and U or V or W, N and U or V or W.

*2 : $125^{\circ}\text{C}/\text{FWD } R_{\text{th}}(\text{j-c})/(\text{Ic} \times \text{Vf MAX})=125/0.855/(75 \times 2.6) \times 100=74.9\%$

*3 : $\text{Pc}=125^{\circ}\text{C}/\text{IGBT } R_{\text{th}}(\text{j-c})=125/0.63=198\text{W}$ [Inverter]

*4 : Vcc shall be applied to the input voltage between terminal No. 3 and 1, 6 and 4, 9 and 7, 11 and 10.

*5 : Vin shall be applied to the input voltage between terminal No. 2 and 1, 5 and 4, 8 and 7, 13,14,15 and 10.

*6 : VALM shall be applied to the voltage between terminal No. 16 and 10.

*7 : IALM shall be applied to the input current to terminal No. 16.

*8 : 50Hz/60Hz sine wave 1 minute.

*9 : Recommendable Value : 2.5 to 3.0 N·m

● **Electrical characteristics** (at $T_c=T_j=25^\circ\text{C}$, $V_{cc}=15\text{V}$ unless otherwise specified.)

Main circuit

Item		Symbol	Condition	Min.	Typ.	Max.	Unit	
INV	Collector current at off signal input	I_{CES}	$V_{CE}=600\text{V}$ V_{in} terminal open.	-	-	1.0	mA	
	Collector-Emitter saturation voltage	$V_{CE(sat)}$	$I_c=75\text{A}$	Terminal	-	-	2.4	V
				Chip	-	2.0	-	
	Forward voltage of FWD	V_F	$-I_c=75\text{A}$	Terminal	-	-	2.6	V
Chip				-	1.6	-		
Turn-on time		t_{on}	$V_{DC}=300\text{V}, T_j=125^\circ\text{C}$	1.2	-	-	μs	
Turn-off time		t_{off}	$I_c=75\text{A}$ Fig.1, Fig.6	-	-	3.6		
Reverse recovery time		t_{rr}	$V_{DC}=300\text{V}, I_c=75\text{A}$ Fig.1, Fig.6	-	-	0.3		
Maximum Avalanche Energy (A non-repetition)		P_{AV}	Internal wiring inductance=50nH Main circuit wiring inductance=54nH	40	-	-	mJ	

● **Control circuit**

Item	Symbol	Condition	Min.	Typ.	Max.	Unit
Supply current of P-line side pre-driver(one unit)	I_{ccp}	Switching Frequency : 0 to 15kHz $T_c=-20$ to 125°C Fig.7	-	-	18	mA
Supply current of N-line side pre-driver	I_{ccn}		-	-	65	mA
Input signal threshold voltage (on/off)	$V_{in(th)}$	ON	1.00	1.35	1.70	V
		OFF	1.25	1.60	1.95	V
Input zener voltage	V_z	$R_{in}=20\text{k ohm}$	-	8.0	-	V
Alarm signal hold time	t_{ALM}	$T_c=-20^\circ\text{C}$ Fig.2	1.1	-	-	ms
		$T_c=25^\circ\text{C}$ Fig.2	-	2.0	-	ms
		$T_c=125^\circ\text{C}$ Fig.2	-	-	4.0	ms
Limiting resistor for alarm	R_{ALM}		1425	1500	1575	ohm

● **Protection Section** ($V_{cc}=15\text{V}$)

Item	Symbol	Condition	Min.	Typ.	Max.	Unit
Over Current Protection Level of Inverter circuit	I_{oc}	$T_j=125^\circ\text{C}$	113		- -	A
Over Current Protection Delay time	t_{doc}	$T_j=125^\circ\text{C}$	-	5	-	μs
SC Protection Delay time	t_{sc}	$T_j=125^\circ\text{C}$ Fig.4	-	-	8	μs
IGBT Chip Over Heating	T_{jOH}	surface of IGBT chips	150		- -	$^\circ\text{C}$
Over Heating Protection Hysteresis	T_{jH}	$V_{DC}=0\text{V}, I_c=0\text{A}$, Case temperature	-	20	-	$^\circ\text{C}$
Over Heating Protection Temperature Level	T_{COH}		110	-	125	$^\circ\text{C}$
Over Heating Protection Hysteresis	T_{CH}		-	20	-	
Under Voltage Protection Level	V_{UV}		11.0	-	12.5	V
Under Voltage Protection Hysteresis	V_H		0.2	0.5	-	

● **Thermal characteristics**($T_c=25^\circ\text{C}$)

Item	Symbol		Min.	Typ.	Max.	Unit
Junction to Case thermal resistance	INV	IGBT	-	-	0.63	$^\circ\text{C/W}$
		FWD	-	-	0.855	$^\circ\text{C/W}$
Case to fin thermal resistance with compound	Rth(c-f)		-	0.05	-	$^\circ\text{C/W}$

● **Noise Immunity** ($V_{DC}=300\text{V}$, $V_{cc}=15\text{V}$, Test Circuit Fig.5)

Item	Condition	Min.	Typ.	Max.	Unit
Common mode rectangular noise	Pulse width $1\mu\text{s}$, polarity \pm , 10minuets Judge : no over-current, no miss operating	± 2.0	-	-	kV
Common mode lightning surge	Rise time $1.2\mu\text{s}$, Fall time $50\mu\text{s}$ Interval 20s, 10 times Judge : no over-current, no miss operating	± 5.0	-	-	kV

● **Recommendable value**

Item	Symbol	Min.	Typ.	Max.	Unit
DC Bus Voltage	V_{DC}	-	-	400	V
Operating Supply Voltage of Pre-Driver	V_{cc}	13.5	15.0	16.5	V
Screw torque (M5)	-	2.5	-	3.0	Nm

● **Weight**

Item	Symbol	Min.	Typ.	Max.	Unit
Weight	W_t	-	450	-	g

*9 : (For 1 device, Case is under the device)

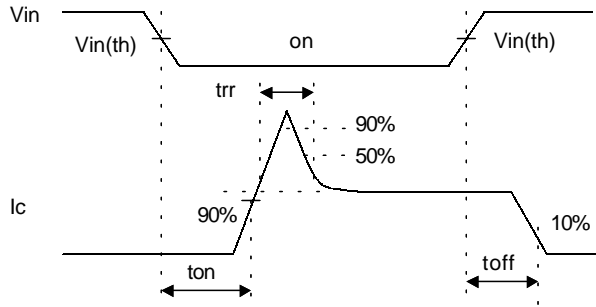
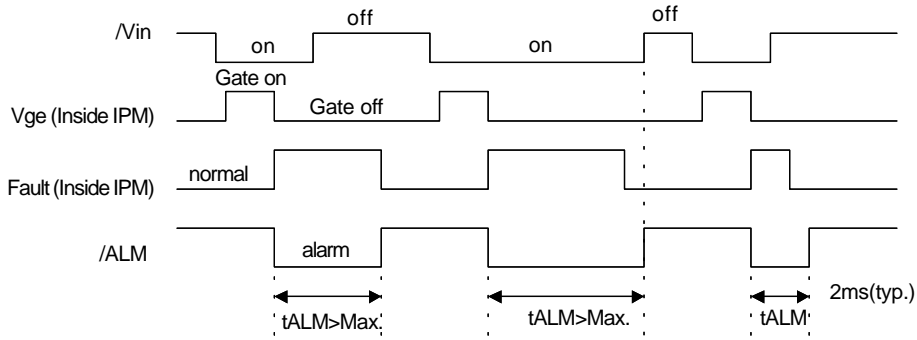

Figure 1. Switching Time Waveform Definitions



Fault : Over-current, Over-heat or Under-voltage

Figure 2. Input / Output Timing Diagram

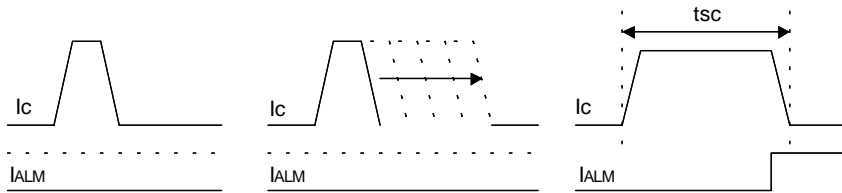

Figure 4 Definition of tsc

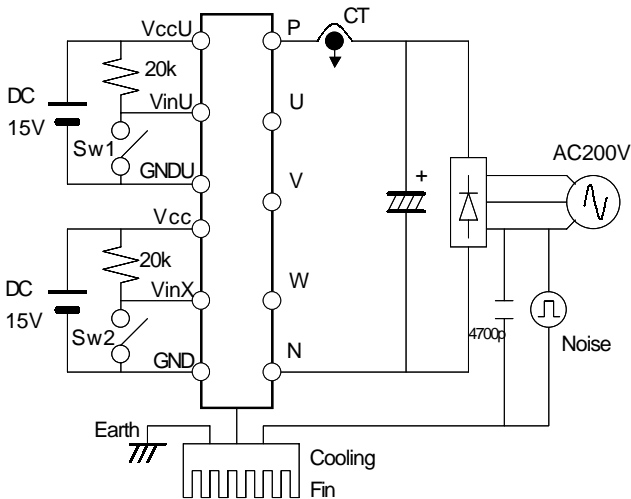

Figure 5. Noise Test Circuit

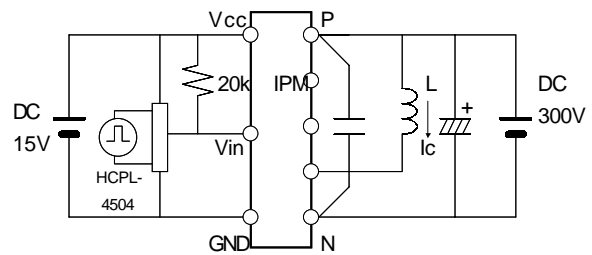

Figure 6. Switching Characteristics Test Circuit

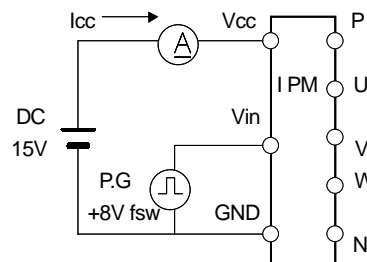
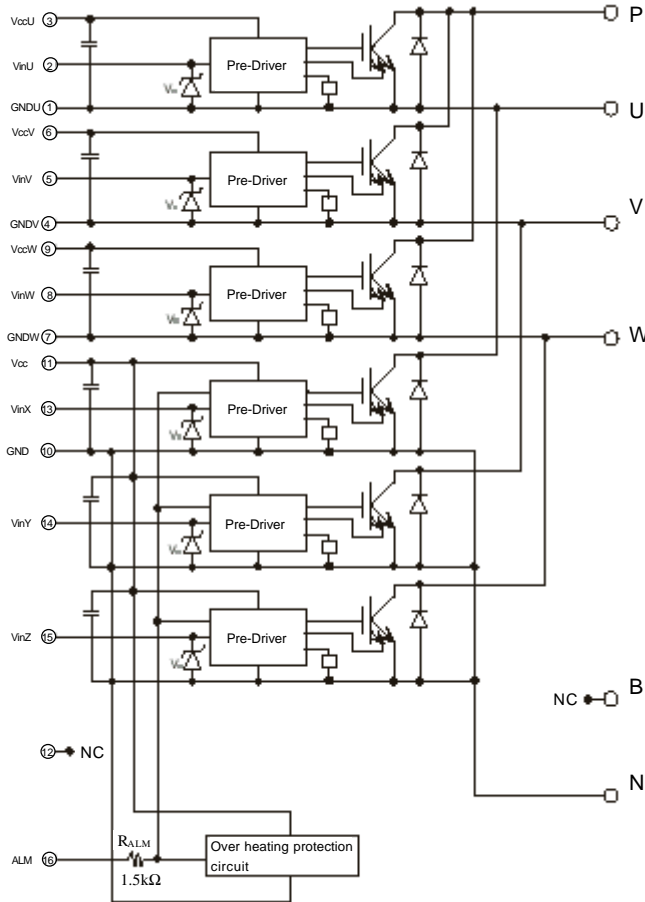

Figure 7. Icc Test Circuit

Block diagram



- Pre-driver include following functions
- ① Amplifier for drive
 - ② Short circuit protection
 - ③ Under voltage lockout circuit
 - ④ Over current protection
 - ⑤ IGBT chip over heating protection

Outline drawings, mm

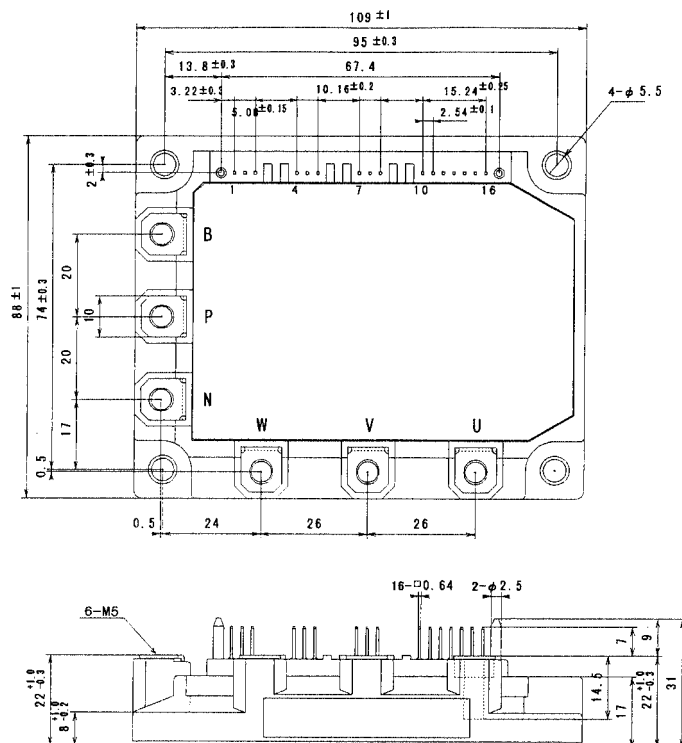

Mass : 450g

Characteristics

Control circuit characteristics (Representative)

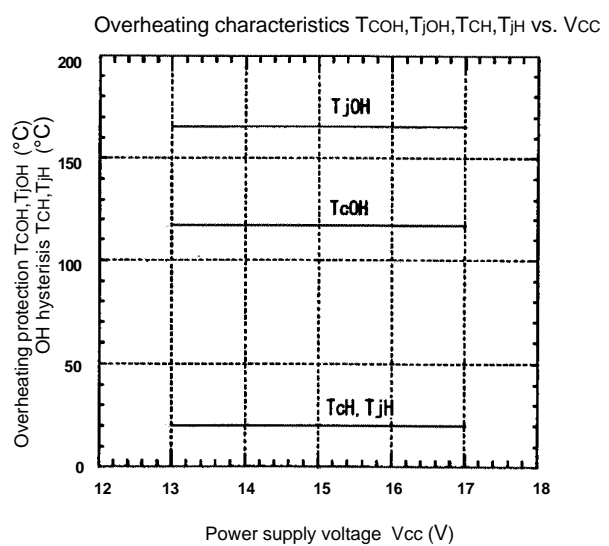
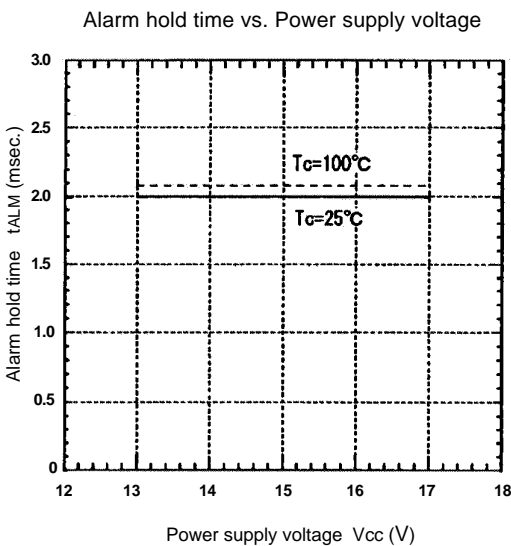
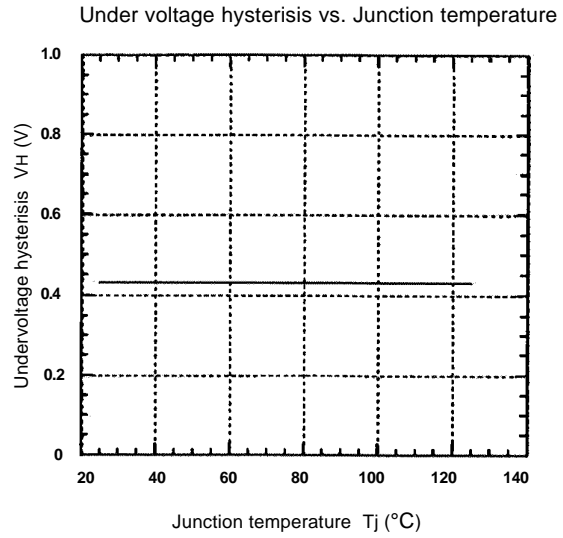
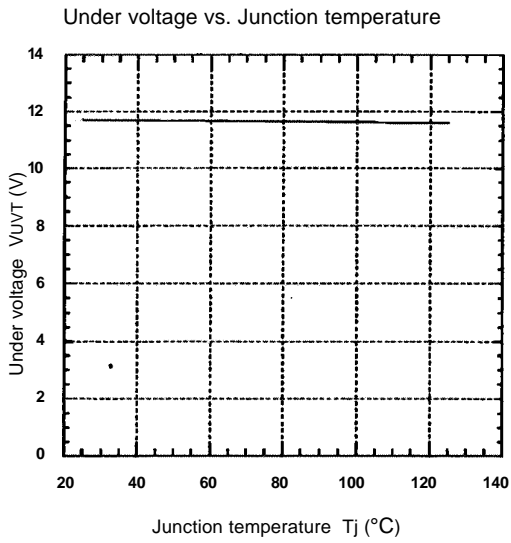
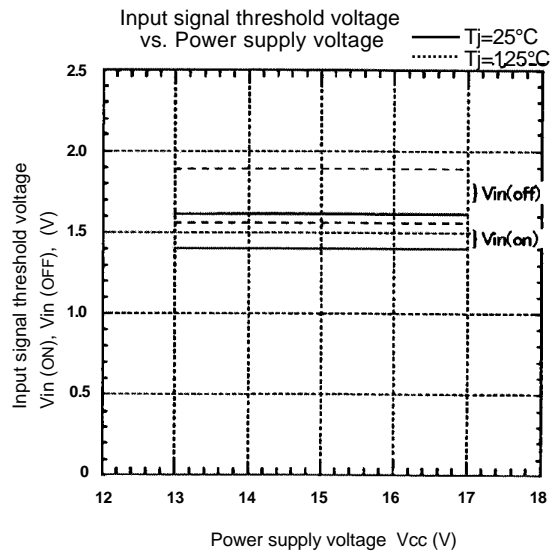
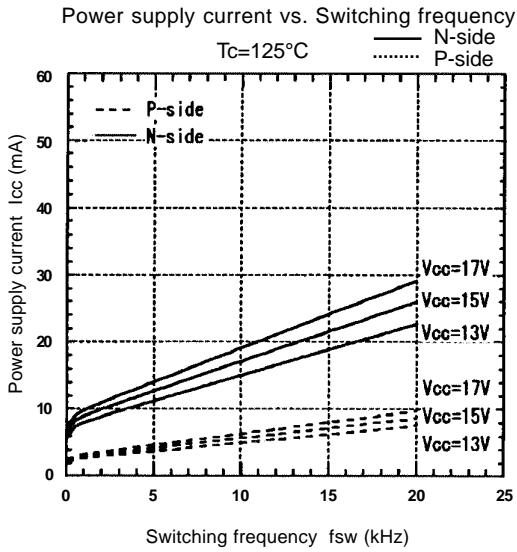

● Main circuit characteristics (Representative)

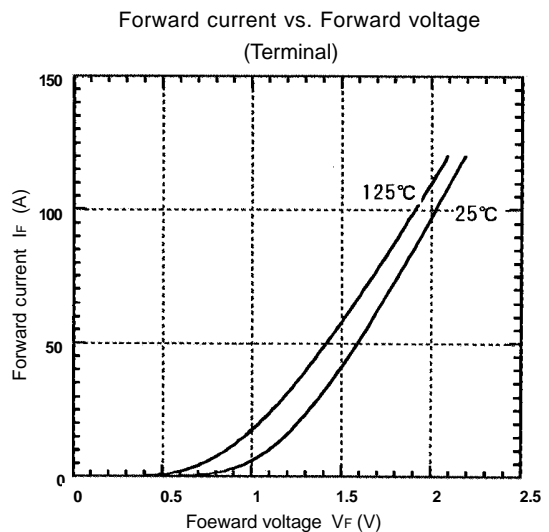
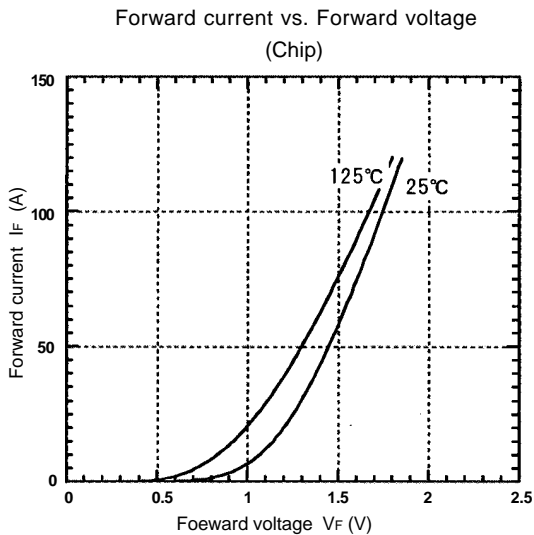
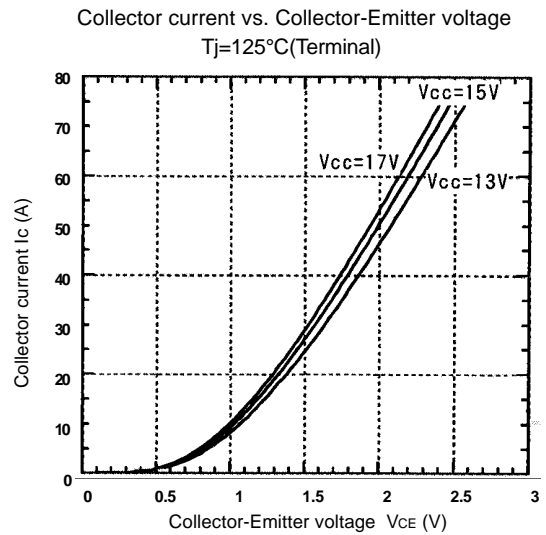
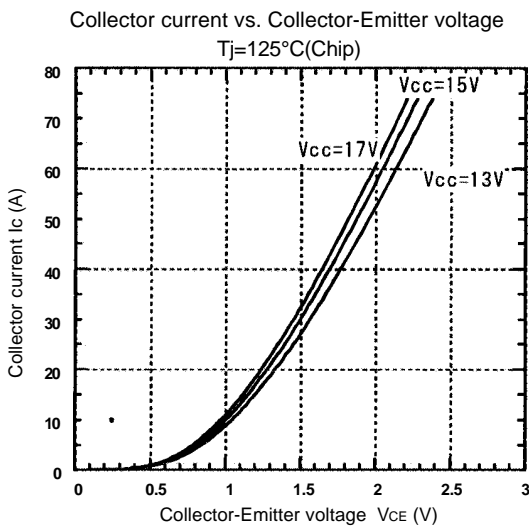
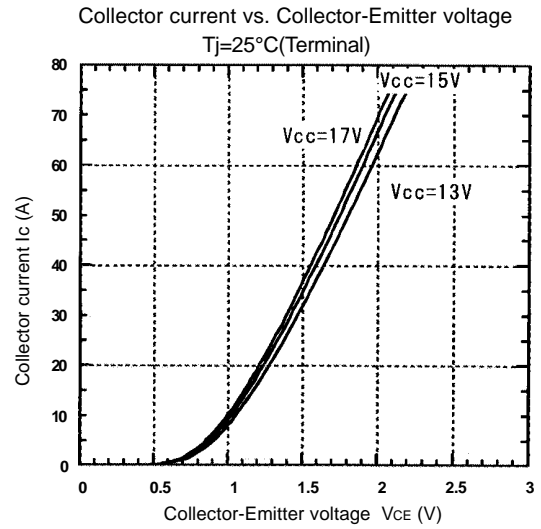
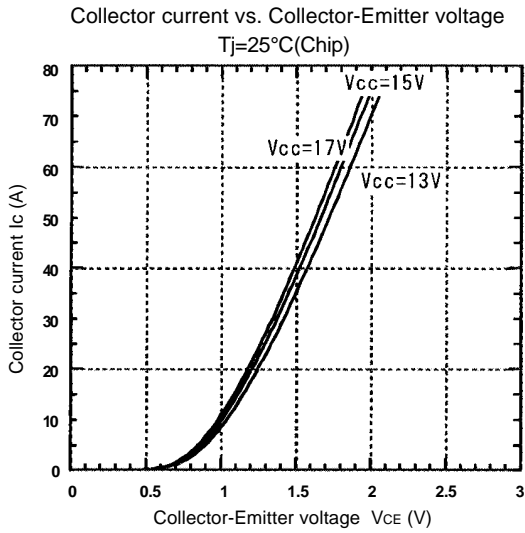

Switching Loss vs. Collector current
 $E_{dc}=300V, V_{cc}=15V, T_j=25^\circ C$

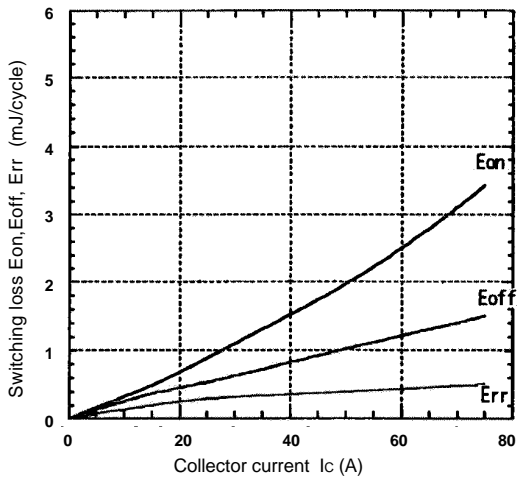

Switching Loss vs. Collector current
 $E_{dc}=300V, V_{cc}=15V, T_j=125^\circ C$

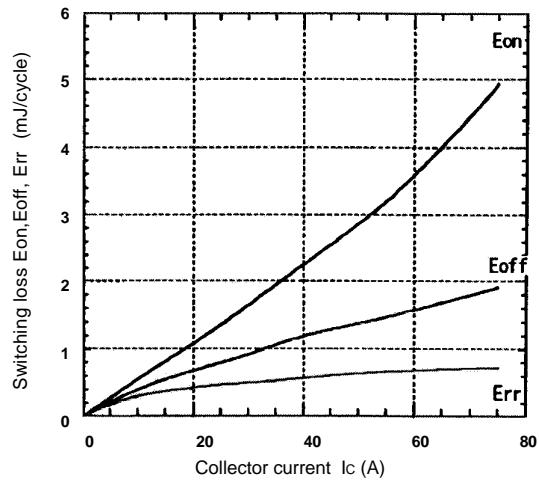

Reverse biased safe operating area
 $V_{cc}=15V, T_j \le 125^\circ C$

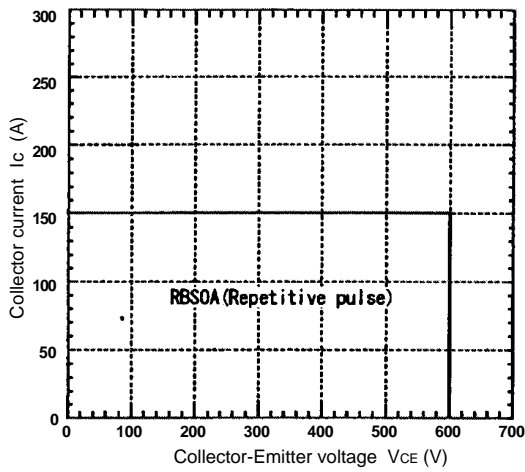

Transient thermal resistance

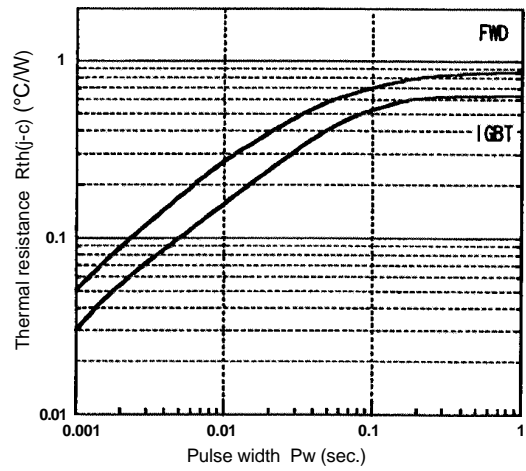

Power derating for IGBT (per device)

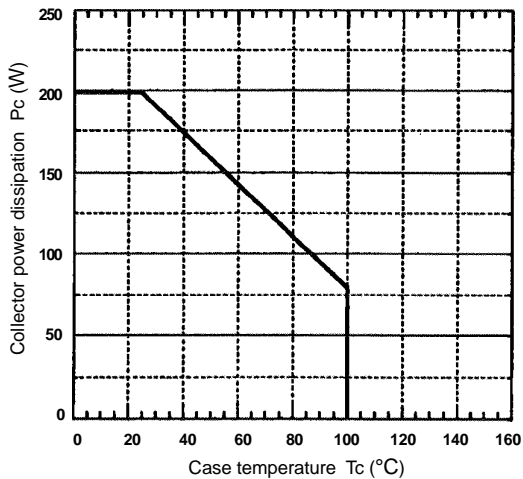

Power derating for FWD (per device)

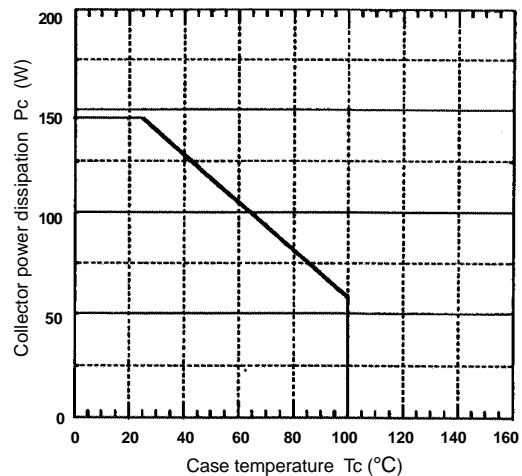

Switching time vs. Collector current
 $E_{dc}=300V, V_{cc}=15V, T_j=25^\circ C$

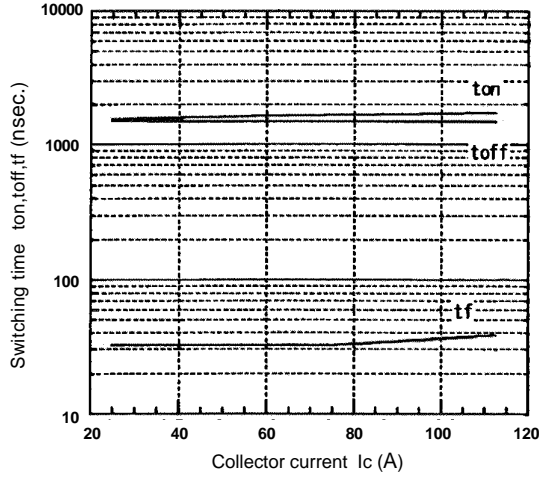

Switching time vs. Collector current
 $E_{dc}=300V, V_{cc}=15V, T_j=125^\circ C$

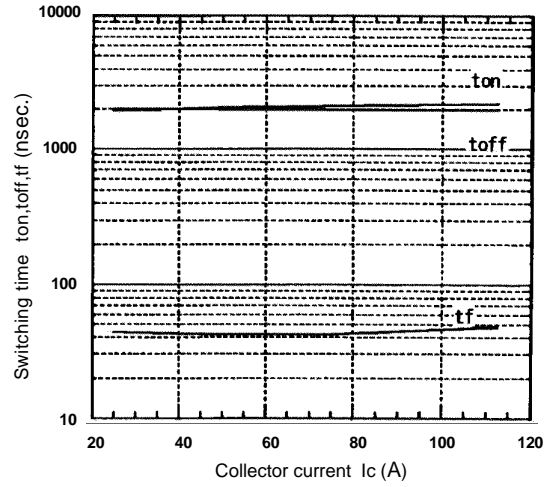

Reverse recovery characteristics
 t_{rr}, I_{rr} , vs. I_F

