

# 6MBI75S-140

IGBT Modules

## IGBT MODULE ( S series) 1400V / 75A 6 in one-package

### ■ Features

- Compact Package
- P.C.Board Mount Module
- Low  $V_{CE(sat)}$

### ■ Applications

- Inverter for Motor drive
- AC and DC Servo drive amplifier
- Uninterruptible power supply
- Industrial machines, such as Welding machines

### ■ Maximum ratings and characteristics

#### ● Absolute maximum ratings (at $T_c=25^\circ\text{C}$ unless otherwise specified)

Item	Symbol	Rating	Unit	
Collector-Emitter voltage	$V_{CES}$	1400	V	
Gate-Emitter voltage	$V_{GES}$	$\pm 20$	V	
Collector current	Continuous	$T_j=25^\circ\text{C}$	100	A
		$T_j=75^\circ\text{C}$	75	
	1ms	$T_j=25^\circ\text{C}$	200	A
		$T_j=75^\circ\text{C}$	150	
		-Ic	75	A
	1ms	-Ic pulse	150	A
Max. power dissipation (1 device)	$P_c$	520	W	
Operating temperature	$T_j$	+150	$^\circ\text{C}$	
Storage temperature	$T_{stg}$	-40 to +125	$^\circ\text{C}$	
Isolation voltage *1	$V_{is}$	AC 2500 (1min.)	V	
Screw torque	Mounting *2	3.5	N·m	

\*1: All terminals should be connected together when isolation test will be done.

\*2: Recommendable value : 2.5 to 3.5 N·m (M5)

#### ● Electrical characteristics (at $T_j=25^\circ\text{C}$ unless otherwise specified)

Item	Symbol	Characteristics			Conditions	Unit	
		Min.	Typ.	Max.			
Zero gate voltage collector current	$I_{CES}$	-	-	1.0	$V_{GE}=0\text{V}$ , $V_{CE}=1400\text{V}$	mA	
Gate-Emitter leakage current	$I_{GES}$	-	-	0.2	$V_{CE}=0\text{V}$ , $V_{GE}=\pm 20\text{V}$	$\mu\text{A}$	
Gate-Emitter threshold voltage	$V_{GE(th)}$	5.5	7.2	8.5	$V_{CE}=20\text{V}$ , $I_c=75\text{mA}$	V	
Collector-Emitter saturation voltage	$V_{CE(sat)}$	-	2.4	2.7	$T_j=25^\circ\text{C}$	$V_{GE}=15\text{V}$ , $I_c=75\text{A}$	V
		-	3.0	-	$T_j=125^\circ\text{C}$		
Input capacitance	$C_{ies}$	-	9000	-	$V_{GE}=0\text{V}$	pF	
Output capacitance	$C_{oes}$	-	1875	-	$V_{CE}=10\text{V}$		
Reverse transfer capacitance	$C_{res}$	-	1650	-	$f=1\text{MHz}$		
Turn-on time	$t_{on}$	-	0.35	1.2	$V_{CC}=800\text{V}$ $I_c=75\text{A}$ $V_{GE}=\pm 15\text{V}$ $R_G=16\Omega$	$\mu\text{s}$	
	$t_r$	-	0.25	0.6			
	$t_{r(i)}$	-	0.1	-			
Turn-off time	$t_{off}$	-	0.45	1.0			
	$t_f$	-	0.08	0.3			
Diode forward on voltage	$V_F$	-	2.6	3.4	$T_j=25^\circ\text{C}$	$I_F=75\text{A}$ , $V_{GE}=0\text{V}$	V
		-	2.2	-	$T_j=125^\circ\text{C}$		
Reverse recovery time	$t_{rr}$	-	-	0.35	$I_F=75\text{A}$	$\mu\text{s}$	

#### ● Thermal resistance characteristics

Item	Symbol	Characteristics			Conditions	Unit
		Min.	Typ.	Max.		
Thermal resistance	$R_{th(j-c)}$	-	-	0.24	IGBT	$^\circ\text{C/W}$
	$R_{th(j-c)}$	-	-	0.50	FWD	$^\circ\text{C/W}$
	$R_{th(c-f)*2}$	-	0.05	-	the base to cooling fin	$^\circ\text{C/W}$

\*2 : This is the value which is defined mounting on the additional cooling fin with thermal compound



### ■ Equivalent Circuit Schematic

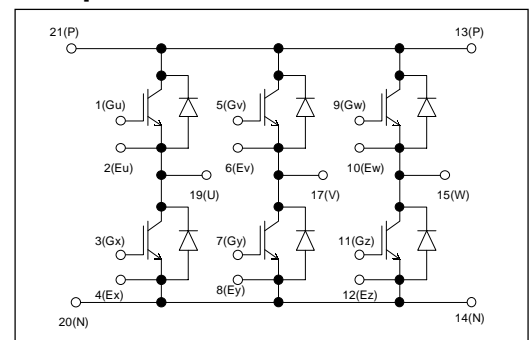

■ Characteristics

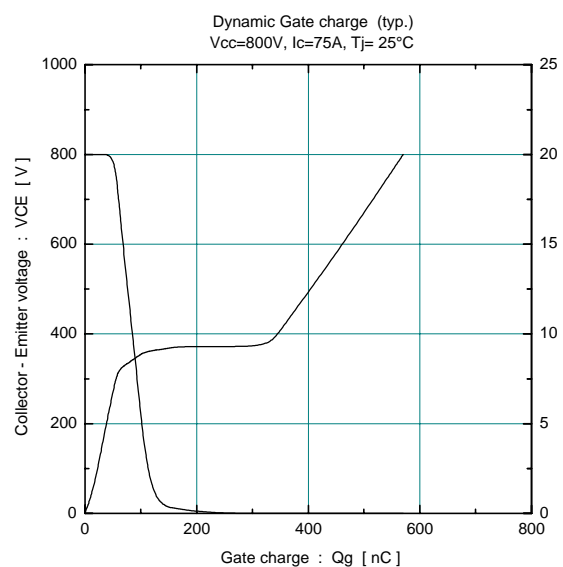
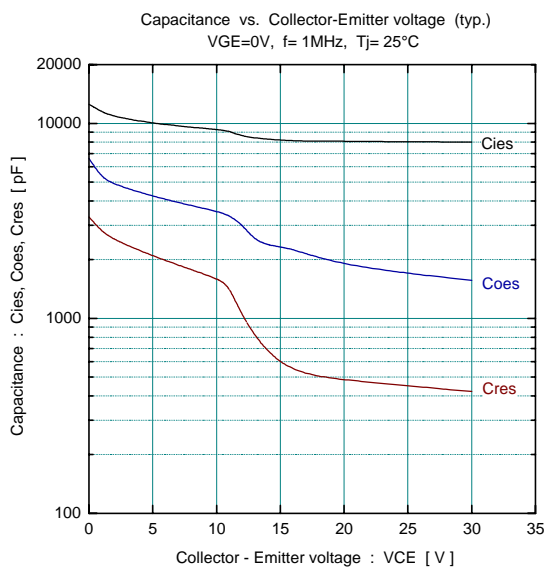
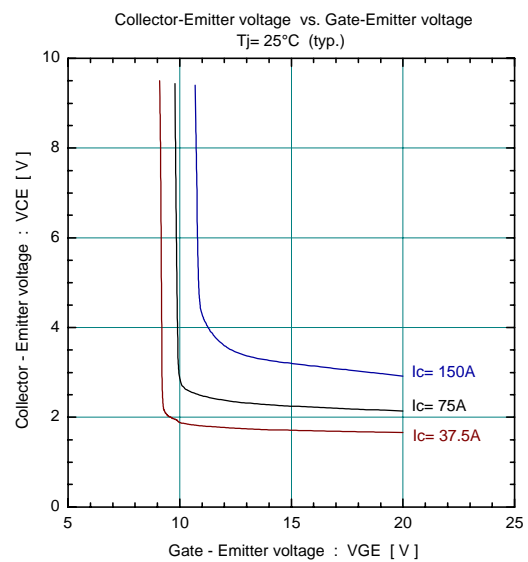
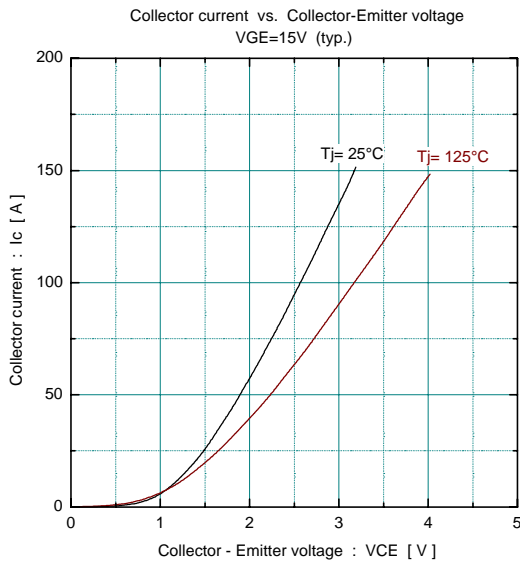
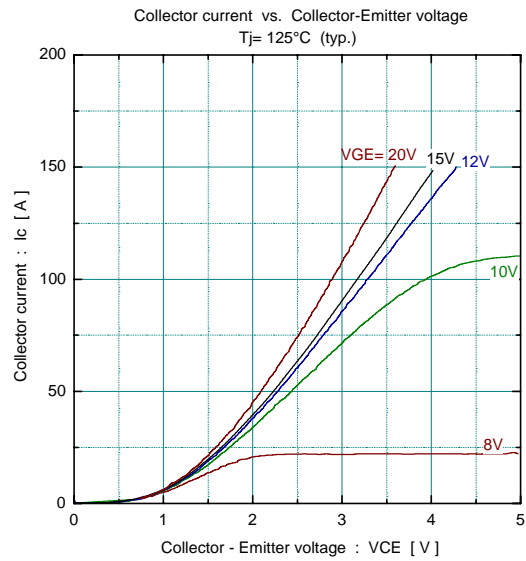
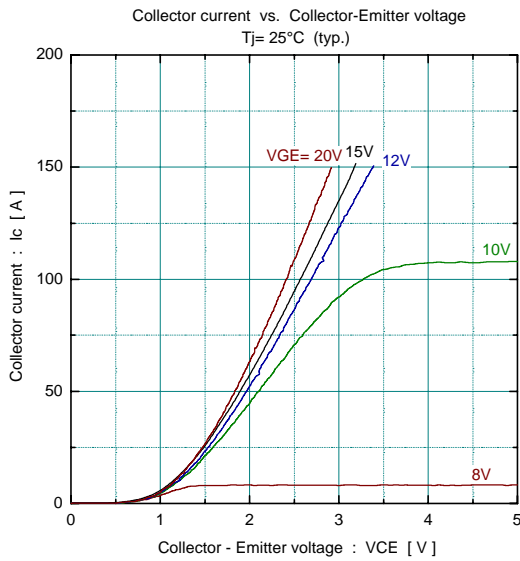

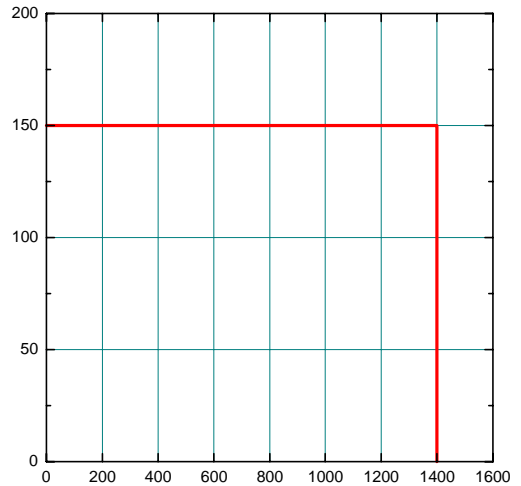
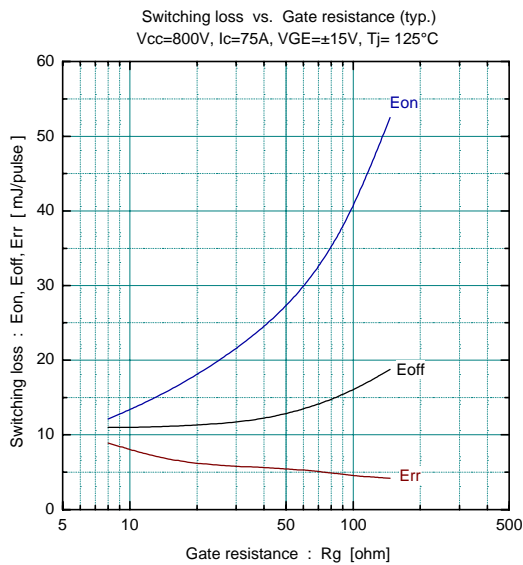
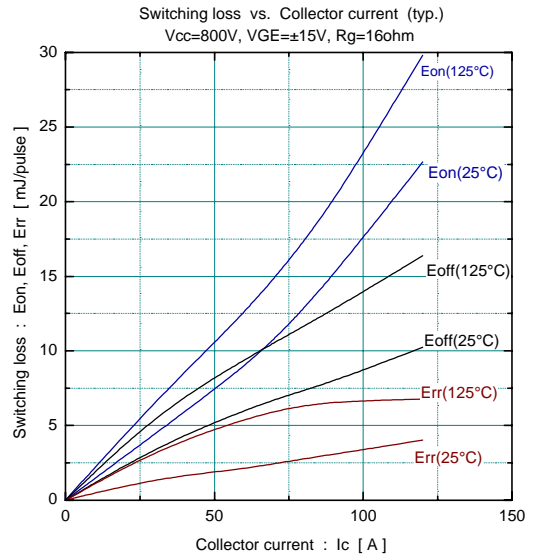
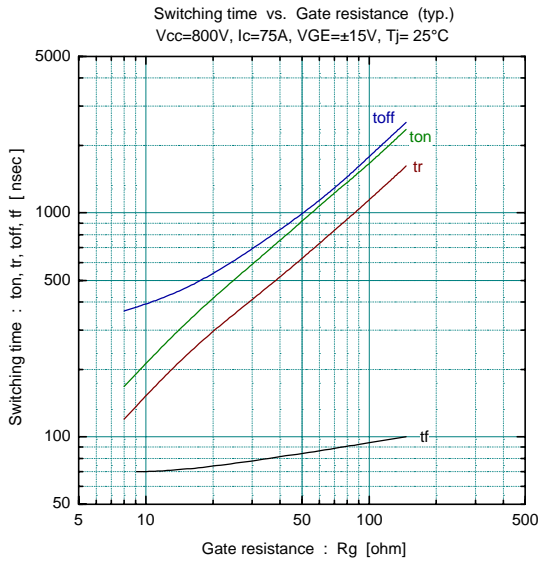
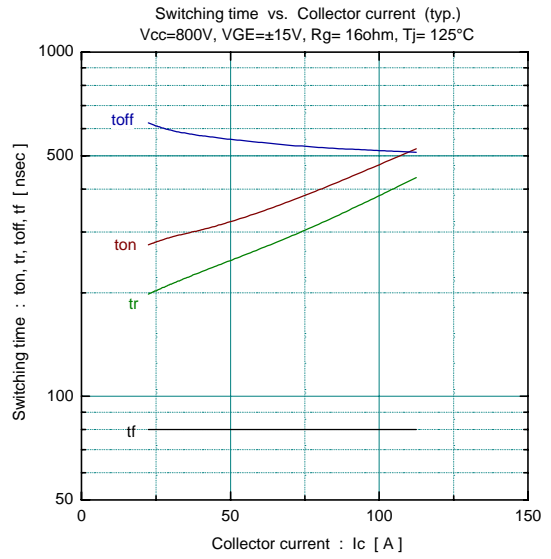
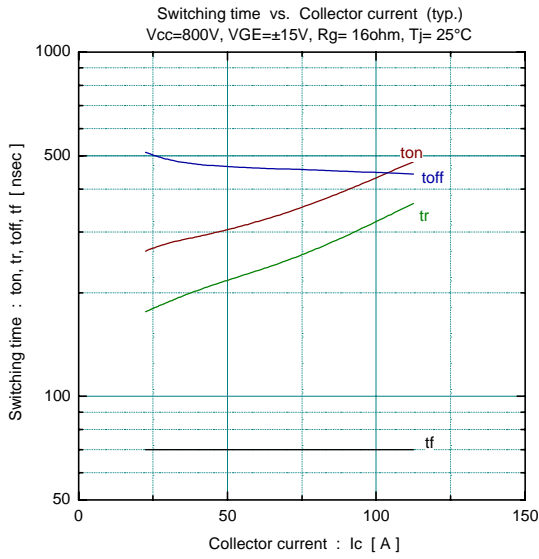

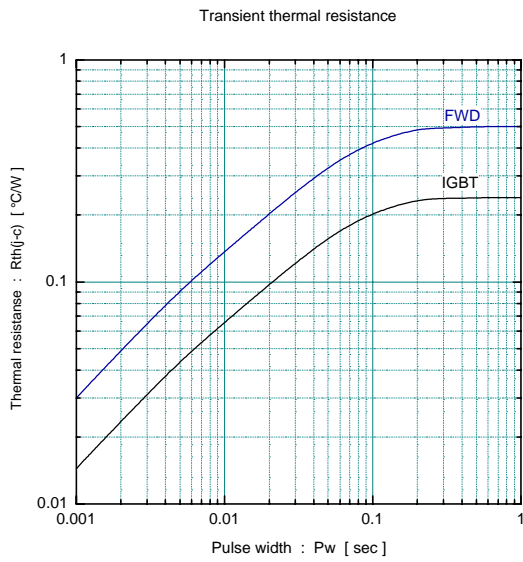
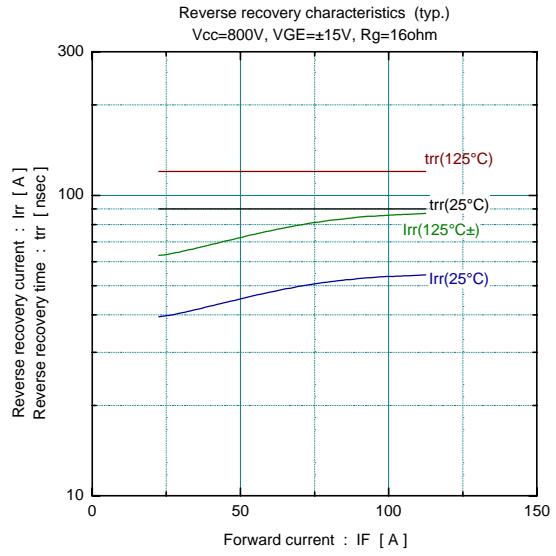
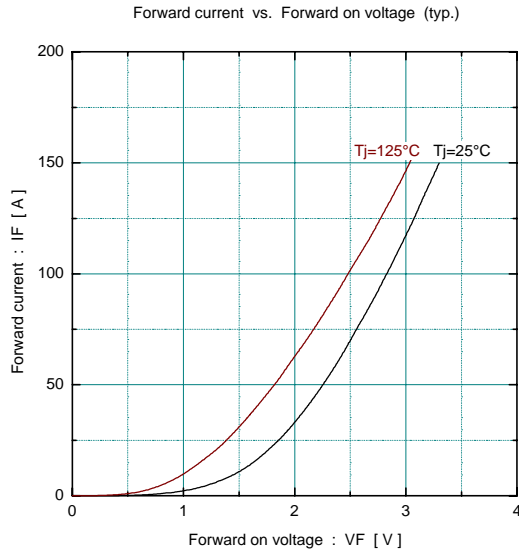

■ Outline Drawings, mm

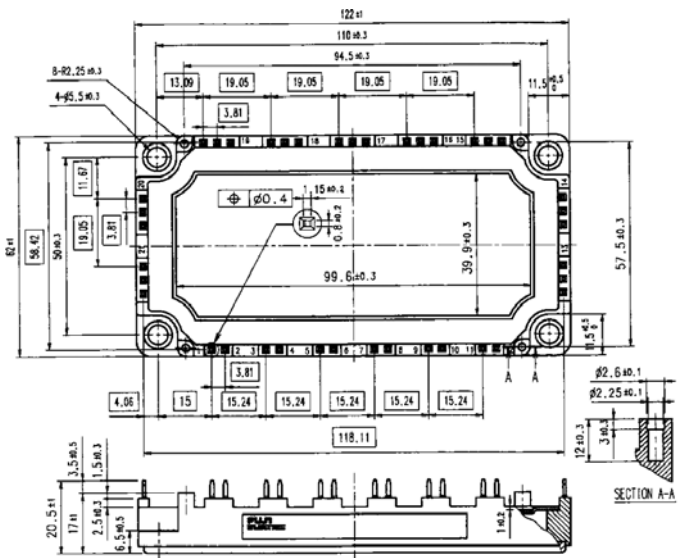

mass : 260g

□ shows theoretical dimension.